

# ALUMINIUM-HAUSTÜREN



 **ISARHOLZ**®

# TREND



Diese Serie beinhaltet Modelle ohne Verglasungsrahmen und Ausführungen ohne Verglasung. Sie sind in ADS 75B.SI innen und außen flächenbündig und in den Systemen ADS 95.SI, ADS 95AK.SI, ADS 75.SI einseitig flügelüberdeckend oder beidseitig flügelüberdeckend erhältlich. Darüber hinaus wählen Sie zwischen Nuten und Applikationen außen oder beidseitig, sowie außenliegender LED-Leuchten.

Auf der Seite 60 - 61 stellen wir Ihnen eine Auswahl gestalterischer Farben vor.



AT 894

Farbe DB 703 Fs Matallic  
 + Dekor Altholz (Stadelholz- 1N), querfurniert  
 Nuten 4/10  
 Glasmotiv SG 894  
 Aussengriff P 3208  
 Led-Dioden LI

Ud (Wm<sup>2</sup>/K)  
 EFS | 1,3 (Ug 0,7) | BFS | 0,89 (Ug 0,5)



AT 100

Farbe Dekor Altholz (Stadelholz- 1N), querfurniert  
 + Carbon Night Matt Metallic  
 Aussengriff 316 838  
 Öffnung mit Fingerprint

Ud (Wm<sup>2</sup>/K)  
 EFS | 1,2\* | BFS | 0,84\*



Modell AT 265/AST 100A

Farbe Carbon Night Matt Metallic  
Original Platinum Matt Metallic  
Nuten 4/10  
Glasmotiv SM 265  
Aussengriff SP5G 17 mit Mini-Kamera

Ud (Wm <sup>2</sup> /K)	
EFS   1,2*	BFS   0,84*

AT 131

Farbe HD Eiche 4, querfurniert  
Ral 7005 FS  
Glas Orn. Satinato weiss  
Aussengriff P 3217 - S

Ud (Wm <sup>2</sup> /K)	
EFS   1,2 (Ug 0,7)	BFS   0,89 (Ug 0,5)



## AT 266

Farbe Night Grey Fs Metallic  
 Nuten 5/20  
 Aussengriff 310 054 mit integriertem Fingerprint

Ud (Wm <sup>2</sup> /K)	
EFS   1,2*	BFS   0,84*



## AT 266A

Farbe Night Grey Fs Metallic  
 + Dekor Altholz  
 (Stadelholz-1N), querfurniert  
 Nuten 5/20  
 Aussengriff 310 034

Ud (Wm <sup>2</sup> /K)	
EFS   1,2*	BFS   0,84*



## AT 264A/ AST 100A

Farbe Artic Ice Fs Metallic  
 Nuten 2/10  
 Glasmotiv SM 264A  
 Aussengriff SG 134

Ud (Wm <sup>2</sup> /K)	
EFS   1,2*	BFS   0,84*



### AT 909/AST 100A

Farbe Night Grey Fs Metallic  
+ HD Nuss I  
Applikation Edelstahl 4/10  
Nuten 3/10  
Glasmotiv SM 909  
Aussengriff 314 597

Ud (Wm <sup>2</sup> /K)	
EFS   1,2*	BFS   0,84*

### AT 919

Farbe Granit Nature Fs Metallic  
+ HD Eiche Dunkel  
Applikation Edelstahl 4/10  
Glas Or. satinato weiss  
Aussengriff 310 056 mit integriertem  
Fingerprint

Ud (Wm <sup>2</sup> /K)	
EFS   1,3 (Ug 0,7)	BFS   0,91 (Ug 0,5)



## AT 121

Farbe Ral 7035 Fs  
 Nuten 7/10  
 Aussengriff 310 033  
 Hausnummer flächenbündig, schwarz

Ud (Wm <sup>2</sup> /K)	
EFS   1,2*	BFS   0,84*



## AT 907

Farbe Granit Nature Fs Metallic  
 + Artic Ice Fs Metallic  
 Applikation Edelstahl 6/10  
 Aussengriff P 3212

Ud (Wm <sup>2</sup> /K)	
EFS   1,2*	BFS   0,84*



## AT 810/AST 100A

Farbe Original Platinum Matt Metallic  
 Nuten 12/10  
 Glas Orn. Satinato weiss  
 Aussengriff SG 180  
 Wetterschenkel WSE 03

Ud (Wm <sup>2</sup> /K)	
EFS   1,3 (Ug 0,7)	BFS   0,91 (Ug 0,5)





AT 264

Farbe Dekor Concrete Beton optik  
+ Cast Iron Fs Metallic  
Applikation Edelstahl 2/10  
Aussengriff GS 113

Ud (Wm <sup>2</sup> /K)	
EFS   1,2*	BFS   0,84*



Modell AT 265A

Farbe Dekor Beton dunkel  
+ Ral 7024  
Applikation Edelstahl 4/10  
Aussengriff ZAE 66

Ud (Wm <sup>2</sup> /K)	
EFS   1,2*	BFS   0,84*



AT 862A/AST 100A

Farbe 6768 Braun Fs  
 Applikation Edelstahl 6/10  
 Glasmotiv SG 862A, SM 862A  
 Aussengriff 310 059 mit LED

Ud (Wm<sup>2</sup>/K)  
 EFS | 1,3 (Ug 0,7) | BFS | 0,92 (Ug 0,5)



AT 801B

Farbe Dekor Concrete Beton optik  
 + Ral 9005 Fs  
 Applikation Aluminium 2/10, Ral 9005 Fs  
 Glas Orn. Satinato weiss  
 Aussengriff 316 839

Ud (Wm<sup>2</sup>/K)  
 EFS | 1,3 (Ug 0,7) | BFS | 0,91 (Ug 0,5)



### AT 906A

Farbe Granit Nature Fs Metallic  
 Applikation Edelstahl 1/20, 5/10  
 Glas Orn. Satinato weiss  
 Aussengriff P 3214

Ud (Wm<sup>2</sup>/K)

EFS	1,3 (Ug 0,7)	BFS	0,92 (Ug 0,5)
-----	--------------	-----	---------------



### AT 906

Farbe Granit Nature Fs Metallic  
 + HD Douglas 7  
 Applikation Edelstahl 5/10, 1/20  
 Glasmotiv SG 906  
 Aussengriff 314 597

Ud (Wm<sup>2</sup>/K)

EFS	1,3 (Ug 0,7)	BFS	0,92 (Ug 0,5)
-----	--------------	-----	---------------



### AT 941A/AST 100A

Farbe Night Grey Fs Metallic  
 Applikation Edelstahl 6/10  
 Glas Orn. Satinato weiss  
 Aussengriff SG 124 mit integriertem  
 Fingerprint

Ud (Wm<sup>2</sup>/K)

EFS	1,3 (Ug 0,7)	BFS	0,92 (Ug 0,5)
-----	--------------	-----	---------------



AT 891A

Farbe HD Eiche 2  
 Nuten 6/20  
 Glasmotiv SG 891A  
 Aussengriff 310 024

Ud (Wm<sup>2</sup>/K)  
 EFS | 1,2 (Ug 0,7) | BFS | **0,97** (Ug 0,5)



AT 867

Farbe Ral 9016 Fs  
 Glasmotiv SG 867  
 Aussengriff 310 021

Ud (Wm<sup>2</sup>/K)  
 EFS | 1,2 (Ug 0,7) | BFS | **0,99** (Ug 0,5)



### AT 102

Farbe Russet Copper Fs Metallic  
 Glas klar  
 Aussengriff 316 866 schräge Befestigung

Ud (Wm <sup>2</sup> /K)	
RT	1,4 (Ug 0,7)   1,3 (Ug 0,5)



### AT 101

Farbe Ral 7016 Fs  
 Glas klar  
 Aussengriff P 3217  
 Öffnung mit Fingerprint

Ud (Wm <sup>2</sup> /K)	
RT	1,3 (Ug 0,7)   1,2 (Ug 0,5)



### AT 100A/AST 100A

Farbe Ral 9016 Fs  
 Glas Orn. Satinato weiss  
 Aussengriff ZAE 66 - S

Ud (Wm <sup>2</sup> /K)	
RT	1,2 (Ug 0,7)   1,1 (Ug 0,5)



AT 944

Farbe HD Douglas 6  
 Glas Orn. Satinato weiss  
 Aussengriff P 3214  
 Wetterschenkel WSE 03

Ud (Wm<sup>2</sup>/K)  
 EFS | 1,3 (Ug 0,7) | BFS | 0,91 (Ug 0,5)



AT 945A

Farbe GSPED 0 Matt  
 + HD Nuss I  
 Glas Orn. Satinato weiss  
 Aussengriff P 3217- S  
 Öffnung mit Fingerprint

Ud (Wm<sup>2</sup>/K)  
 EFS | 1,3 (Ug 0,7) | BFS | 0,93 (Ug 0,5)



### AT 946B

Farbe Precious Sand Fs Metallic  
 Nuten 14/20  
 Glasmotiv SG 946A  
 Aussengriff 310 024

Ud (Wm<sup>2</sup>/K)

---

EFS | **1,3** (Ug 0,7) | BFS | **0,92** (Ug 0,5)



### AT 946A

Farbe Night Grey Fs Metallic  
 Glasmotiv SG 946A  
 Aussengriff J-137 - Gold Supreme  
 Fs Metallic im Türflügel integriert

Ud (Wm<sup>2</sup>/K)

---

EFS | **1,3** (Ug 0,7) | BFS | **0,92** (Ug 0,5)



### AT 924A/AST 100A

Farbe Rumbling Sky Fs Metallic  
 Nuten 8/10  
 Glasmotiv SG 924A, SM 924A  
 Aussengriff 310 037

Ud (Wm<sup>2</sup>/K)

---

EFS | **1,3** (Ug 0,7) | BFS | **0,93** (Ug 0,5)





### AT 948/AST 100A

Farbe Artic Ice Fs Metallic  
 Nuten 2/10  
 Glasmotiv Sandgestraht, SM 948  
 Aussengriff ZAE 66 - S

Ud (Wm <sup>2</sup> /K)	
EFS   1,3 (Ug 0,7)	BFS   0,97 (Ug 0,5)



### AT 934

Farbe Cast Iron Fs Metallic  
 Applikation Edelstahl 4/10  
 Glas Orn. Satinato weiss  
 Aussengriff P 3212  
 Wetterschenkel WSE 03

Ud (Wm <sup>2</sup> /K)	
EFS   1,3 (Ug 0,7)	BFS   0,92 (Ug 0,5)



AT 863A/ AST 100A

Farbe Rostiges Eisen Fs  
 Applikation Edelstahl 4/10  
 Glasmotiv Sandgestrahlt, SM 863A  
 Aussengriff P 3214

Ud (Wm<sup>2</sup>/K)  
 EFS | 1,3 (Ug 0,7) | BFS | 0,92 (Ug 0,5)



AT 863B

Farbe DB 703 Metallic glatt  
 Nuten 5/10  
 Glas Orn. Satinato weiss  
 Aussengriff SG 124 mit integriertem  
 Fingerprint  
 Wetterschenkel WSE 03

Ud (Wm<sup>2</sup>/K)  
 EFS | 1,3 (Ug 0,7) | BFS | 0,92 (Ug 0,5)



### AT 943

Farbe Original Platinum Matt Metallic  
 Applikation Edelstahl 9/10  
 Glas Orn. Satinato weiss  
 Aussengriff P 3217

Ud (Wm<sup>2</sup>/K)  
 EFS | **1,3** (Ug 0,7) | BFS | **0,93** (Ug 0,5)



### AT 863C

Farbe Brown Fs Metallic  
 Applikation Edelstahl 7/10  
 Glas Orn. Satinato weiss  
 Aussengriff P 3217

Ud (Wm<sup>2</sup>/K)  
 EFS | **1,3** (Ug 0,7) | BFS | **0,91** (Ug 0,5)



### AT 947/AST 100A

Farbe Cast Iron Fs Metallic  
 Glasmotiv Sandgestraht, SM 947  
 Aussengriff 310 039

Ud (Wm<sup>2</sup>/K)  
 EFS | **1,3** (Ug 0,7) | BFS | **0,94** (Ug 0,5)



AT 864/AST 100A

Farbe GSPED 3 Matt  
 Nuten 6/10  
 Glasmotiv Sandgestraht, SM 864  
 Aussengriff 314 585

Ud (Wm<sup>2</sup>/K)  
 EFS | 1,4 (Ug 0,7) | BFS | 1,0 (Ug 0,5)

AT 904

Farbe Volcanish Ash Fs Metallic  
 Applikation Edelstahl 4/20, 1/60  
 Glas Orn. Satinato weiss  
 Aussengriff 316 860

Ud (Wm<sup>2</sup>/K)  
 EFS | 1,3 (Ug 0,7) | BFS | 0,92 (Ug 0,5)



## AT 267

Farbe DB 703 Metallic glatt  
 Applikation Edelstahl 10/20  
 Glas nur in Orn. Satinato weiss beidseitig  
 Aussengriff 314 585

Ud (Wm <sup>2</sup> /K)	
EFS	1,2 (Ug 0,7)   BFS
	0,84 (Ug 0,5)



## AT 843/AST 100A

Farbe Ral 7016 Fs  
 Applikation Edelstahl 2/50  
 Glas Orn. Satinato weiss  
 Aussengriff 314 598

Ud (Wm <sup>2</sup> /K)	
EFS	1,3 (Ug 0,7)   BFS
	0,89 (Ug 0,5)



## AT 875A

Farbe Noble Bronze Matt Metallic  
 Applikation Edelstahl 2/10  
 Glas Orn. Satinato weiss  
 Aussengriff 310 024

Ud (Wm <sup>2</sup> /K)	
EFS	1,3 (Ug 0,7)   BFS
	0,97 (Ug 0,5)



AT 887

Farbe Original Platinum Matt Metallic  
+ HD Eiche dunkel  
Applikation Edelstahl 4/10  
Glas Orn. Satinato weiss  
Aussengriff ZAE 66R  
Öffnung mit Fingerprint

Ud (Wm<sup>2</sup>/K)  
EFS | 1,3 (Ug 0,7) | BFS | 0,92 (Ug 0,5)



AT 887B

Farbe GSPED 0 Matt  
Nuten 4/10  
Glasmotiv SG 887B  
Aussengriff SG 124 mit integriertem  
Fingerprint

Ud (Wm<sup>2</sup>/K)  
EFS | 1,3 (Ug 0,7) | BFS | 0,92 (Ug 0,5)



### AT 153A

Farbe Cast Iron Fs Metallic  
 Glas Orn. Satinato weiss  
 Aussengriff ZAE 66R  
 Öffnung mit Fingerprint

Ud (Wm<sup>2</sup>/K)

---

EFS | 1,4 (Ug 0,7) | BFS | 1,0 (Ug 0,5)



### AT 255

Farbe Precious Sand Fs Metallic  
 + HD Eiche Dunkel, querfurniert  
 Nuten 5/10  
 Glas Orn. Satinato weiss  
 Aussengriff ZAE 66

Ud (Wm<sup>2</sup>/K)

---

EFS | 1,4 (Ug 0,7) | BFS | 1,0 (Ug 0,5)



### AT 883/AST 100A

Farbe Rumbling Sky Fs Metallic  
 + Artic Ice Fs Metallic  
 Applikation Edelstahl 3/10 + 1 Form  
 Glasmotiv Sandgestrahlt, SM 883  
 Aussengriff TG 80

Ud (Wm<sup>2</sup>/K)

---

EFS | 1,3 (Ug 0,7) | BFS | 0,92 (Ug 0,5)

## ALUPROFILE

- Das Alurahmenprofil in der Stärke 75 oder 95mm mit gerader, und eckiger abgerundeter Linienführungen. ADS 75B.SI - beidseitig flächenbündige Ausführung.
- Das Alufügelprofil hat die Stärke 85 mm und 75 mm.
- In der Mitte des Rahmen- und Flügelprofils ist ein Thermokern, der die Wärmedämmcharakteristik des Profils verbessert.
- Die Füllungen sind aus hartem PUR Schaum und haben eine gute Wärmedämmcharakteristik.
- Bei den Ausführungen beidseitig flügelüberdeckend ohne Glasausschnitt und Türgröße 1100 x 2100 mm, wird ein Ud Wert von 0,84 W/m<sup>2</sup>K erreicht. Ein Ud Wert von 1,2 W/m<sup>2</sup>K wird bei einseitig flügelüberdeckenden Alu-Haustüren erzielt.



## BESCHLAG

- Elegante Qualitätsbänder.
- Standard 5-fach Verriegelung des Flügels.
- Verschiedene Öffnungsoptionen; öffnen nach außen, öffnen mit einem Fingerprintsystem, elektrisches öffnen, .....

## VERGLASUNG

- Zur Auswahl steht Ihnen eine breite Palette an Wärme-, Schallschutz und Sicherheitsgläsern, sowie an Ornament- und Bleiverglasungen.
- Zur Gestaltung der Gläser stehen Ihnen verschiedene Folien, sandgestrahlte Motive und andere Gestaltungsmöglichkeiten zur Verfügung.



## OBERFLÄCHENBECHANDLUNG

- Eine qualitäts und umweltfreundliche Pulverbeschichtung.
- Eine große Auswahl aktueller Standardfarben.
- Zur Verfügung stehen RAL Farben matt, RAL Feinstruktur, Metallic- und einbrennlackierte Holzdekore.

ÖFFNUNG

Nach innen öffnende Türen, Ansicht von **außen**



DIN LINKS



DIN RECHTS

TYPENÜBERSICHT

Nach innen öffnende Türen, Ansicht von **innen**

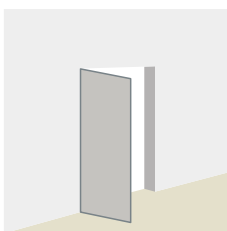

Typ 01

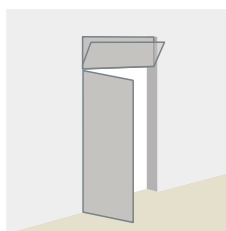

Typ 02/03

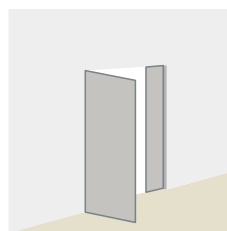

Typ 04

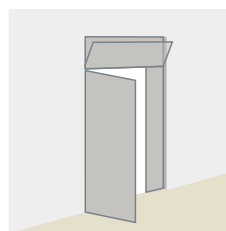

Typ 05/06

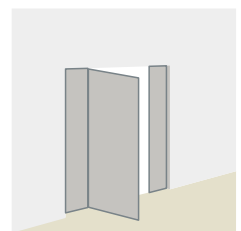

Typ 07

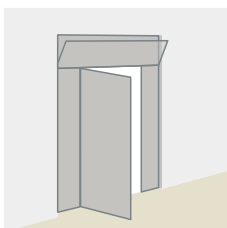

Typ 08/09

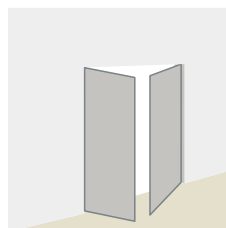

Typ 21

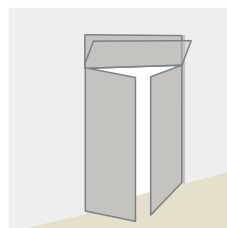

Typ 22/23

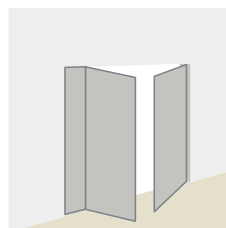

Typ 24

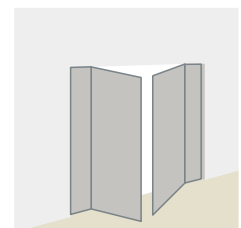

Typ 25

## Aluminium Haustür **aussen**

Modell AT 100, System ADS 75B.SI

**außen flächenbündig**

Farbe: Flügel Dekor Altholz (Stadelholz- IN), querfurniert

Rahmen: Cast Iron Fs Metallic



## Holz/Alu Fenster **außen**

INO-HA80-MM **flächenbündig**

INO-HA80-F **flächenbündig**

Farbe Alu: Cast Iron Fs Metallic

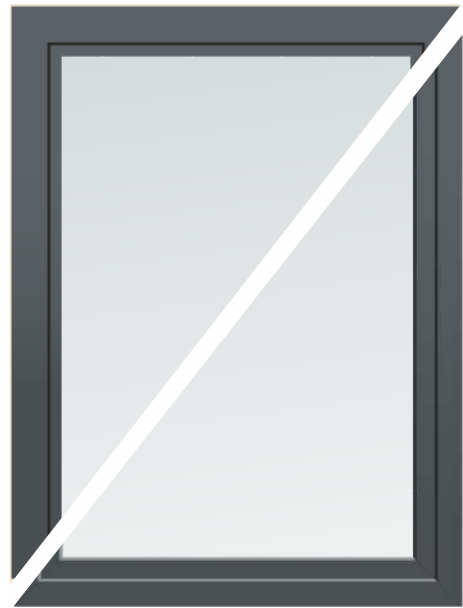

## Kunststoff/Alu Fenster **außen**

Living Top Alu flächenversetzt

Farbe Alu: Cast Iron Fs Metallic

## BEDIENUNGSKOMFORT



Öffnung der Haustüre  
mit dLine Fingerprint



Öffnung der Haustüre  
mit Idencom Fingerprint



Griff SG 124 mit integriertem  
Fingerprint dLine



Smart unilock  
Multifunktions-Keypad

## Aluminium Haustür **innen**

Modell AT 100, System ADS 75B.SI

**innen flächenbündig**

Farbe: Flügel und Rahmen: Cast Iron Fs Metallic

### Holz/Alu Fenster **innen**

INO-HA80-MM **flächenbündig**

INO-HA80-F flächenversetzt

Farbe Holz: DB 703



### Kunststoff/Alu Fenster **innen**

Living Top Alu flächenversetzt

Farbe Kunststoff: Mattex Shine dark graphite



### LED LEUCHTEN



Außengriff mit integriertem Led-Leucht,  
Kratzerschutz und Edelstahl Applikation



LED-Diode

### DIGITALER TÜRSPION



mit LCD - Bildschirm

SYSTEM AUSFÜHRUNGEN



**ADS 95AK.SI**  
Eckig Rahmen

Beidseitig flügelüberdeckende Ausführung

**$U_d = 0,81 \text{ W/m}^2\text{K}$**

( $U_d$  Berechnung für Türgröße 1230 x 2180 mm, ohne Glasausschnitt)

**$U_d = 0,84 \text{ W/m}^2\text{K}$**

( $U_d$  Berechnung für Türgröße 1100 x 2100 mm, ohne Glasausschnitt)



**ADS 95.SI**  
Rund Rahmen

Dreifach  
Verglasung

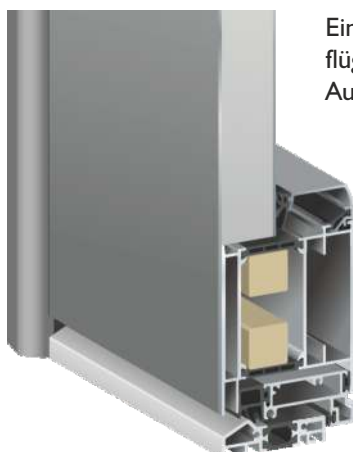

Einseitig  
flügelüberdeckende  
Ausführung aussen

**$U_d = 1,2 \text{ W/m}^2\text{K}$**   
(ohne Glasausschnitt)



Ausführungen mit  
sichtbarem Flügel

Bei diesen Modellen sind die Flügel sichtbar und dieses sowohl innen als auch außen. Sie sind in allen Haustürausführungen außer in der Deluxe Serie erhältlich.



**ADS 75B.SI**

Innen und außen  
flächenbündig

**Ud = 0,83 W/m²K**

(Ud Berechnung für Türgröße 1230 x 2180 mm, ohne Glasausschnitt)

**Ud = 0,87 W/m²K**

(Ud Berechnung für Türgröße 1100 x 2100 mm, ohne Glasausschnitt)

Beidseitig flügelüberdeckende Ausführung

**Ud = 0,81 W/m²K**

(Ud Berechnung für Türgröße 1230 x 2180 mm, ohne Glasausschnitt)

**Ud = 0,84 W/m²K**

(Ud Berechnung für Türgröße 1100 x 2100 mm, ohne Glasausschnitt)



**ADS 75.SI**

außen flächenbündig

VERGLASUNGSRAHMEN AUSFÜHRUNGEN

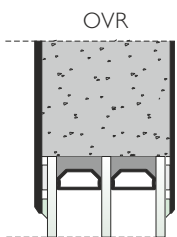

Serie TREND

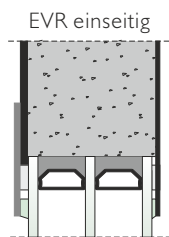

Serie DELUXE  
(Standardausführung)

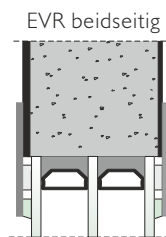

Serie DELUXE

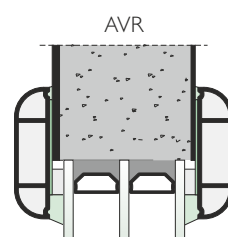

Serien MODERN, CLASSIC

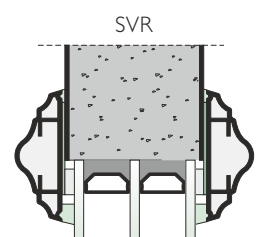

RC2 wir beraten Sie dazu gerne ausführlich.

Die Sicherheit einer Immobilie war und ist ein aktuelles Thema bei dem Kauf von Alu-Haustüren. Ergänzend zu dem in diesem Sinne hohen Qualitätsstandard der Alu-Haustüren als solches, sind diese mit **5-fach Verriegelung (Bolzen und Schwenkriegel)** als **Standardverriegelung** ausgerüstet. Des Weiteren erhalten Sie ISARHOLZ-Alu-Haustüren in den **zertifizierten Sicherheitsstufen RCI und RC2**. Darüber hinaus stehen Ihnen weitere detailrelevante Verriegelungen zur Verfügung. Für einen hohen Bedienungskomfort erhalten Sie individuelle Einrichtungen.

Über die **Sicherheitseinrichtungen für ISARHOLZ-Holz- und Holz/Alu- und Kunststoff-Haustüren** informiert Sie Ihr ISARHOLZ-Fachbetrieb.



## RC2 AUSFÜHRUNG

1 SICHERUNGSBOLZEN



2 SICHERHEITSGLAS P4A



3 FALZLUFTBEGRENZER



4 SICHERHEITSPROFILZYLINDER MIT ANBOHRSCHUTZ

5 SICHERHEITSGARNITUR



3 DREITEILIGES TÜRBÄNDER



Serienmäßig bis Türhöhe 2150 mm mit 3 Bänder und ab 2151 mm mit 4 Bänder gefertigt (standard)

4 TÜRSCHWELLEN

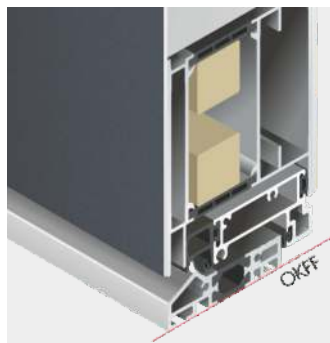

FPI (standard)

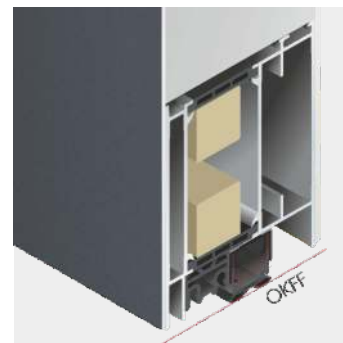

FP5 automatische Türabdichtung

# SICHERHEITSTÜRVERSCHLÜßE



**ATVE 5**  
**5-fach Verriegelung**  
 - Edelstahl  
 mit Bolzen und  
 Schwenkriegel

**Serienmäßige  
 Sicherheit**

- mechanische  
 Mehrfachverriegelung

- 5-fach Schutz durch  
 einen Hauptriegel,  
 2 Bolzen und  
 2 Schwenkriegel



**ATVK 5**  
**5-fach Verriegelung  
 mit Komfortfunktion**  
 - Edelstahl,  
 mit Bolzen und  
 Schwenkriegel

- Mechanisch Öffnen der Tür  
 über Drücker immer möglich  
 (Komfortöffnung)
- Ein Freilaufzylinder oder ein  
 Knaufzylinder erforderlich
- Möglich nur in der Kombination  
 außen Stoßgriff - innen Drücker  
 (Drücker außenseitig nicht  
 möglich)

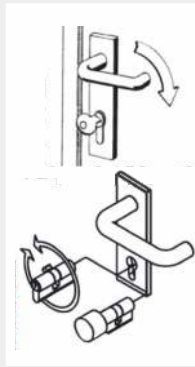

Komfortfunktion  
 = Schnellöffnung  
 von innen über  
 den Drücker

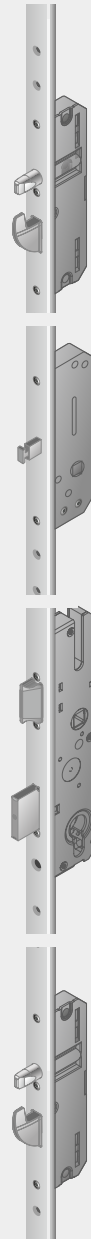

**ATVS 5**  
**5-fach Verriegelung**  
 - Edelstahl  
 mit Bolzen,  
 Schwenkriegel  
 und **Türfänger**

Der spezialgehärtete Sperrbügel  
 sorgt dafür, dass sich die Tür  
 nur einen Spalt breit öffnet, sodass  
 sich kein ungebetener Gast zwischen  
 Tür und Stock durchzwängen kann.

Von innen lässt sich das Fängerschloss  
 einfach über einen Drehknopf  
 bedienen, von außen wird es mit dem  
 Schlüssel über das Hauptschloss  
 betätigt.



## ELEKTRO-TÜRÖFFNER



## VERDECKTLIEGENDE TÜRBÄNDER



Für nach innen öffnende  
 Türen - 100° Öffnungswinkel



Für nach außen öffnende  
 Türen und ADS 75B.SI - 180°

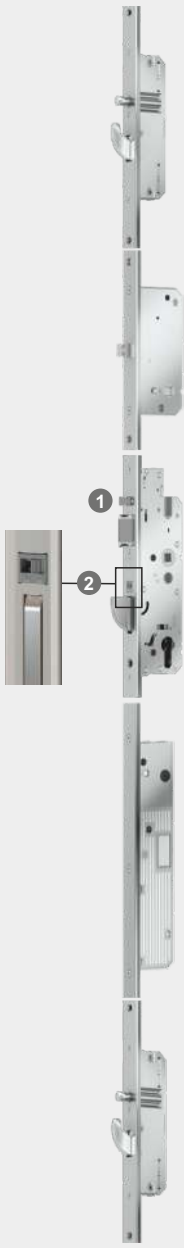

**ATVE A**  
**5-fach Sicherheits-**  
**türverschuß**  
**AUTOMATIK,**  
**MECHANISCH**

*Automatik-Mehrfachverriegelung mit integrierter Selbstjustierung*

- 1 Jederzeit verlässlich sicher. Damit die Tür jederzeit verlässlich verriegelt, die Automatikauslösefalle integrieren.
- 2 Tagesentriegelung: ohne Schlüssel aus dem Haus. Praktisch für alle Alltagssituationen, in denen man das Gebäude kurzzeitig schlüssellos verlassen möchte: einfach die Automatikfunktion mittels Schieber der Tagesentriegelung deaktivieren und die Hauptschloßfalle am Rahmenteil freigeben.

**ATVE A-M**  
**5-fach Sicherheits-**  
**türverschuß**  
**AUTOMATIK,**  
**mit motorischer**  
**Funktion,**  
 inkl. Netzteil

- Verriegelungselementen lassen sich mechanisch verriegeln

- Entriegelung über die Rücksprechanlage, Biometrie, ... (der Riegel des Hauptschlusses darf nicht vorgeschlossen sein)

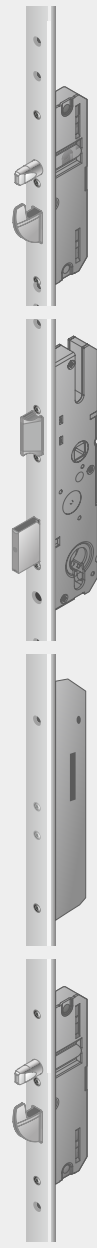

**ATVS 5EA**  
**5-fach Verriegelung Genius**

- Edelstahl, inkl. Netzteil mit elektromechanischem Antrieb, Freilauf-Profilzylinder mit Aufbohrschutz und Gefahrenfunktion einschließlich 6 Schlüsseln.

Achtung: Ausschließlich Zylinder mit Kennzeichnung FZG verwenden!

*Sobald die Tür geschlossen ist, erfolgt im Nachtbetrieb eine automatische Verriegelung durch den Motor (ca. 3 sec.). Alle vorhandenen Verschlusselemente werden herausgefahren.  
 Die Tür kann manuell durch den Zylinderschlüssel oder automatisch über ein externes Zutrittskontrollsystem entriegelt werden.  
 Wenn die Tür vollständig verriegelt ist, ist es auch möglich, von innen über den Drücker alle Riegelemente zurückzufahren und die Tür so schnell zu öffnen.*

**PROFILZYLINDER**



Profilzylinder mit Not- und Gefahrenfunktion und 6 Schlüsseln (standard)



Profilzylinder mit Aufbohrschutz und 6 Schlüsseln



Freilauf-Profilzylinder mit Aufbohrschutz und Gefahrenfunktion einschließlich 6 Schlüsseln

**ZUTRITTSKONTROLLESYSTEM (ATVE A-M, ATVS 5EA GENIUS)**



dLine



dLine Schwarz



Smart unilock

Das smart unilock ist ein innovatives Keypad welches Öffnung per Handy App, Fingerabdruck, code oder RFID in einem Produkt vereint.



Idencom

## Aluminium Haustür **aussen**

Modell AT 894, System ADS 95AK.SI

Farbe: Cast Iron Fs Metallic, HD Walnuss dunkel

Hausnummer Edelstahl

HAUSNUMMER MOTIVGLAS



TÜRSPION



Messing poliert / Satin Chrom

AUSSEN RUNDROSETTE



Edelstahl  
(standard)

schwarz



WETTERSCHENKEL



Briefkasten-Systeme



WSE 03, Edelstahl Applikation



WSE 01, Edelstahl



WSE 02, Edelstahl

## Aluminium Haustür innen

Modell AT 894, System ADS 95AK.SI

Farbe: Ral 9016 FS

Türschließer TS 5000



### INNENGRIFFE, INNENROSETTE

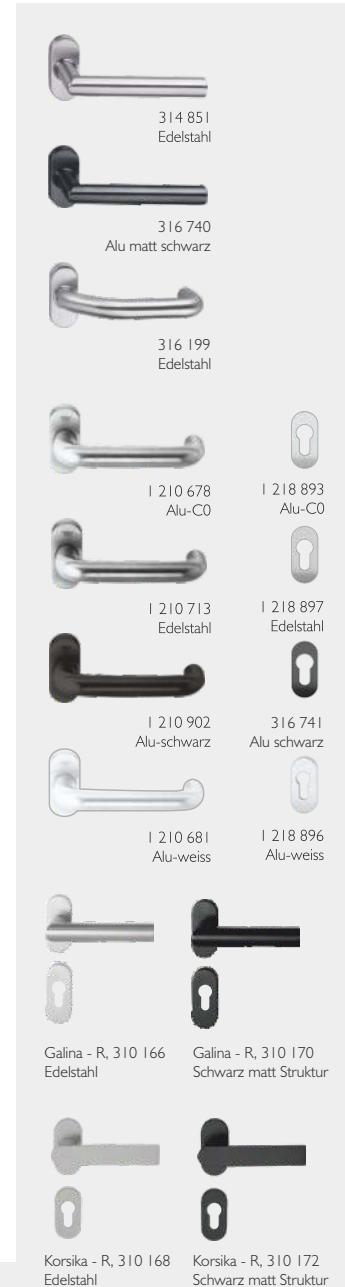

Dreiteilige Rolltürbänder

### Innengriffe I 200



## GRIFFSCHALEN



V 107  
L=1400 mm

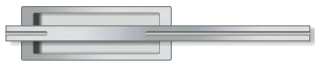

GS-113



GS-88

## STOßGRIFFE



SG-49

## INTEGRIERTE GRIFFLEISTE

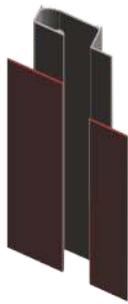

J 137 flächenbündig

integrierte Griffleiste  
- Ral farbe; sichtbarer  
Schlitz = 45mm  
Länge in mm nach  
Wunsch

## AUßENGRIFFE



Edelstahl  
matt /  
Holz Jatoba

SG 134  
L=1600 mm



Edelstahl  
matt /  
Holz Eiche

SG 180  
L=1200 mm



Edelstahl  
matt /  
Holz Jatoba

SG 124  
L=1200 mm

Mit integriertem  
Fingerprint  
dLine



Edelstahl  
matt /  
Holz Jatoba

SPSG 17  
L=1200 mm

Mit Mini-  
Kamera

## LED-DIODEN, Licht farbe weiß, Led-Diodelampe Edelstahl

□ L 1 (57 x 57 mm)    ○ L 2 (Ø=41 mm)

○ L 3 (Ø=60 mm)    ○ L 5 (Ø=30 mm)

● L 4 (Ø=35 mm)

## AUßENROSETTE

Edelstahl    Schwarz    Edelstahl    Edelstahl    Schwarz

RRE    RRE-S    316 238    316 239 (6)  
316 240 (9)    316 741 (6)  
316 742 (9)

Edelstahl matt  
ZAE 66R  
L=X mm



Edelstahl matt  
310 048  
L=382 mm



Edelstahl matt  
310 047  
L=382 mm













## DRÜCKERGARNITUR, WECHELGARNITUR

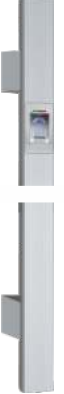

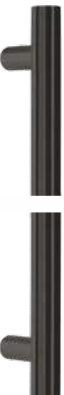
Alu - FI silber  
314 866



Alu - FI silber  
314 863

 <p>Edelstahl matt 310 036 L=1000 mm 310 037 L=1200 mm 310 038 L=1400 mm 310 039 L=1500 mm 310 040 L=1600 mm</p>	 <p>Edelstahl matt ZAE 66 L = x</p>	 <p>Edelstahl matt 314 585 L=400 mm 314 586 L=800 mm 314 597 L=1200 mm 314 598 L=1600 mm 316 847 L=1800 mm 314 599 L=2000 mm</p>	 <p>Edelstahl matt 310 017 L=400 mm 310 019 L=800 mm 310 021 L=1200 mm 310 024 L=1500 mm 310 025 L=1600 mm 310 026 L=1800 mm 310 027 L=2000 mm</p>	 <p>Edelstahl matt P 3217 L = x P 3202 L=350 mm P 3204 L=550 mm P 3206 L=750 mm P 3208 L=950 mm P 3210 L=1150 mm P 3212 L=1350 mm</p>	 <p>Edelstahl matt mit Fräsung für Fingerscan Idecom 310 049 L=1000 mm 310 050 L=1300 mm 310 051 L=1500 mm 310 052 L=1600 mm</p>	 <p>Edelstahl matt mit Led 310 058 L=1000 mm 310 059 L=1400 mm</p>
 <p>Schwarz matt Struktur 310 041 L=1000 mm 310 042 L=1200 mm 310 043 L=1300 mm 310 044 L=1400 mm 310 045 L=1500 mm 310 046 L=1600 mm</p>	 <p>Schwarz ZAE 66-S L = x</p>	 <p>Schwarz matt Struktur 316 834 L=1000 mm 316 835 L=1200 mm 316 837 L=1400 mm 316 838 L=1500 mm 316 839 L=1600 mm</p>	 <p>Schwarz matt Struktur 310 029 L=1000 mm 310 030 L=1200 mm 310 032 L=1400 mm 310 033 L=1500 mm 310 034 L=1600 mm 310 035 L=1800 mm</p>	 <p>Schwarz P 3217-S L = x</p>	 <p>Edelstahl matt mit Fräsung für Fingerscan dLine 310 053 L=1000 mm 310 054 L=1300 mm 310 055 L=1400 mm 310 056 L=1500 mm 310 057 L=1600 mm</p>	 <p>Edelstahl matt mit LED und zusätzlicher Fräsung für Fingerscan dLine 310 060 L=1000 mm</p>

 <p>Edelstahl matt Mit schräger oder gerader Befestigung TG 50 L=500 mm TG 60 L=600 mm TG 80 L=800 mm TG 100 L=1000 mm TG 120 L=1200 mm</p>	 <p>TG 140 L=1400 mm TG 160 L=1600 mm TG 180 L=1800 mm</p>	 <p>Edelstahl matt Mit schräger Befestigung 316 865 L=400 mm 316 866 L=600 mm 316 867 L=800 mm 316 868 L=1000 mm 316 869 L=1200 mm</p>	 <p>Edelstahl matt Mit gerader Befestigung 316 860 L=400 mm 316 861 L=600 mm 316 862 L=800 mm 316 863 L=1000 mm 316 864 L=1200 mm</p>
--	---	---	--

KRATZERSCHUTZ

 <p>Edelstahl 381 112 60 X 75 mm</p>	 <p>Edelstahl 381 114 55 X 75 mm</p>
---	---



Edelstahl 310 174	Edelstahl 310 179	Edelstahl 310 184	Edelstahl matt 316 668	Edelstahl matt 316 671	Edelstahl matt 316 662	Edelstahl matt 316 665
----------------------	----------------------	----------------------	---------------------------	---------------------------	---------------------------	---------------------------

# FARBGESTALTUNGEN

Vielfältige Farbgestaltungen für die Alu-Oberflächen  
Auszug

## MASTER COLLECTION feinstruktur, metallic



Iceberg Blue  
Feinstruktur Metallic



Rumbling Sky  
Feinstruktur Metallic



Night Grey  
Feinstruktur Metallic



Cast Iron  
Feinstruktur Metallic



Russet Copper  
Feinstruktur Metallic



Brown  
Feinstruktur Metallic

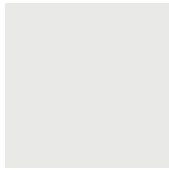

Artic Ice  
Feinstruktur Metallic



Precious Sand  
Feinstruktur Metallic



Verdigris  
Feinstruktur Metallic



Granit Nature  
Feinstruktur Metallic



Volcanic Ash  
Feinstruktur Metallic



Elves Bench  
Feinstruktur Metallic

## ANODIZING COLLECTION matt, metallic



ORIGINAL PLATINIUM  
Matt Metallic

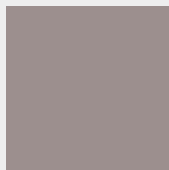

SILVER DREAM  
Matt Metallic

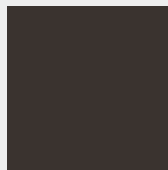

CARBON NIGHT  
Matt Metallic



DARK COPPER  
Matt Metallic



SIMPLY COPPER  
Matt Metallic



GREY BD  
Matt Metallic

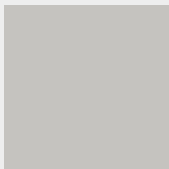

GSPED 0  
Matt



GSPED 1  
Matt

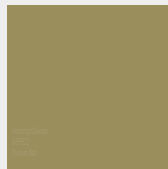

GSPED 2  
Matt



GSPED 3  
Matt

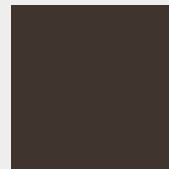

GSPED 4  
Matt



NOBLE BRONZE  
Matt Metallic

## RAL FARBEN matt, feinstruktur, metallic, glatt

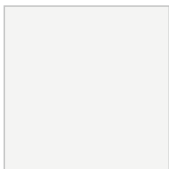

RAL 9016  
Feinstruktur



RAL 7040  
Feinstruktur

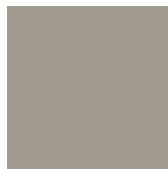

RAL 7039  
Feinstruktur



RAL 7012  
Feinstruktur



RAL 7015  
Feinstruktur



RAL 7016  
Feinstruktur

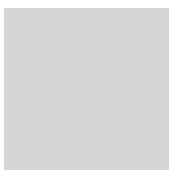

RAL 9006  
Metallic glatt



RAL 9007  
Metallic Feinstruktur



DB 703  
Metallic Feinstruktur



RAL 7021  
Feinstruktur



RAL 9005  
Feinstruktur



RAL 8019  
Feinstruktur

STEINDEKOR



Dekor Concrete  
Beton optik



Dekor Beton dunkel

HOLZDEKOR



Dekor Altholz  
(Stadelholz-1N)

DEKOR PRÄGEDECKLAGE - SERIE TREND AT 100 **New Forest**



Dekor ATTERSEE



Dekor  
WOLFGANGSEE



Dekor TRAUNSEE

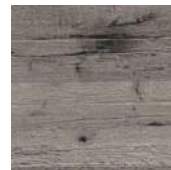

Dekor MONDSSEE



Dekor ALTAUSSEE

HOLZDEKOR (struktur)

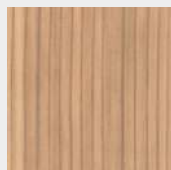

Douglas 6

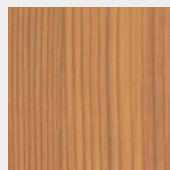

Douglas 7

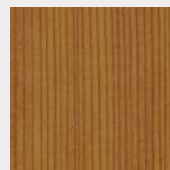

Douglas 2

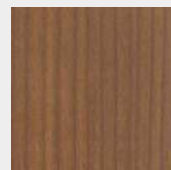

Kirsch 2

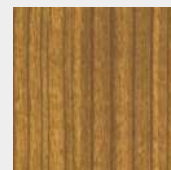

Kirsch 3

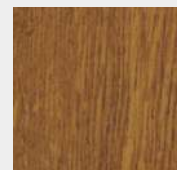

Golden Oak



Eiche 2

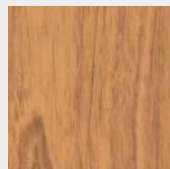

Eiche 4

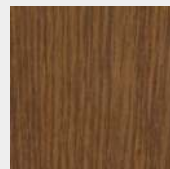

Eiche dunkel

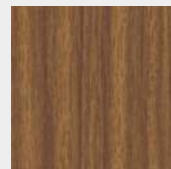

Nuss 1

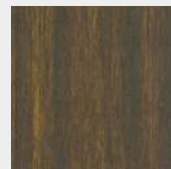

Walnuss dunkel



Wenge

HOLZDEKOR - Serie REFINED



Nussbaum FS

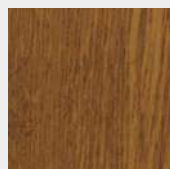

Golden Eiche FS



Helle Eiche

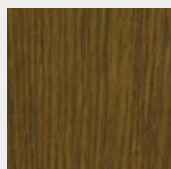

Dunkel Eiche

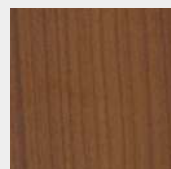

Kirsche

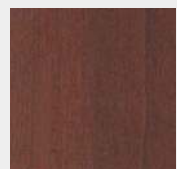

Mahagoni

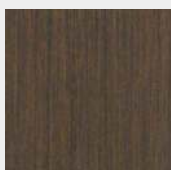

Wenge

ORNAMENTGLÄSER



Kathedral Klein. weiss



Chinchilla weiss

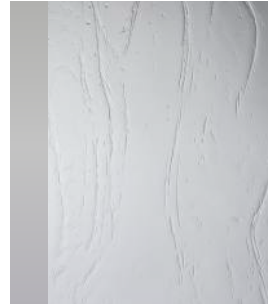

Gothic weiss

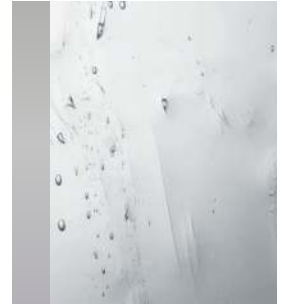

Altdeutsch K weiss

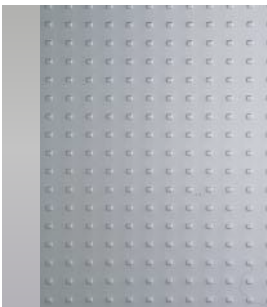

Mastercarre weiss



Masterligne weiss

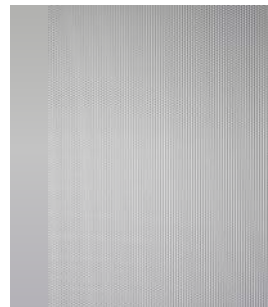

Masterpoint weiss

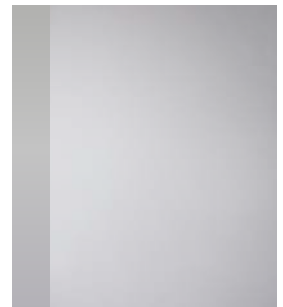

Satinato weiss

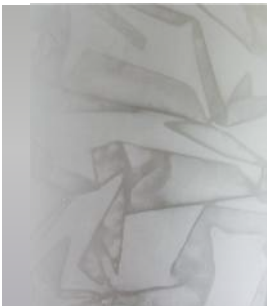

Silk weiss

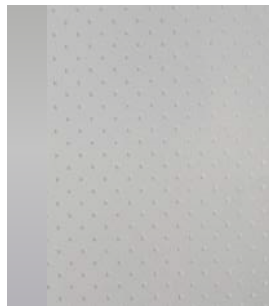

Pave weiss

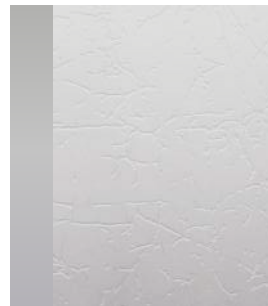

Uadi weiss

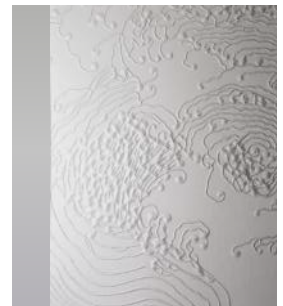

Nebulosa weiss

WÄRMESCHUTZGLAS

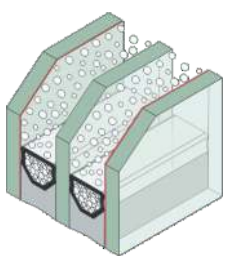

dreifach

SANDGESTRAHLTE MOTIVE

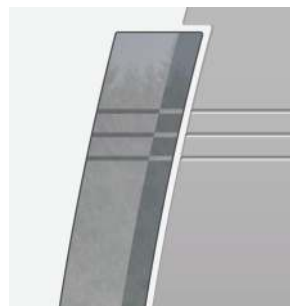

REFINED  
AR



Triumph - Seite 7



Canary/ AST 100A - Seite 6



Levent - Seite 7

TREND  
New Forest  
AT



AT 100 **NF** Attersee



AT 100 **NF** Wolfgangsee  
- Seite 8



AT 100 **NF** Mondsee  
- Seite 9



AT 100 **NF** Traunsee  
- Seite 9



AT 100/ AST 100A **NF** Altausee  
- Seite 9

TREND  
AT



AT 100A/ AST 100A - Seite 21



AT 101 - Seite 21



AT 102 - Seite 21



AT 100 - Seite 11



AT 121 - Seite 15



AT 131 - Seite 12



AT 153A - Seite 31



AT 255 - Seite 31



AT 264 - Seite 17

## ABGEBILDETE TÜREN IN DER ÜBERSICHT



AT 264A/AST 100A - Seite 13



AT 265/AST 100A - Seite 12



AT 265A - Seite 17



AT 266 - Seite 13



AT 266A - Seite 13



AT 267 - Seite 29



AT 801B - Seite 18



AT 810/AST 100A - Seite 15



AT 843/AST 100A - Seite 29



AT 862A/AST 100A - Seite 18



AT 863A/AST 100A - Seite 26



AT 863B - Seite 26



AT 863C - Seite 27



AT 864/AST 100A - Seite 28



AT 867 - Seite 20



AT 875A - Seite 29



AT 883/AST 100A - Seite 31



AT 887 - Seite 30



AT 887B - Seite 30



AT 891A - Seite 20



AT 894 - Seite 11



AT 904 - Seite 28



AT 906 - Seite 19



AT 906A - Seite 19



AT 907 - Seite 15



AT 909/AST 100A - Seite 14



AT 919 - Seite 14



AT 924A/AST 100A - Seite 23



AT 934 - Seite 25



AT 941A/AST 100A - Seite 19



AT 943 - Seite 27



AT 944 - Seite 22



AT 945A - Seite 22



AT 946A - Seite 23



AT 946B - Seite 23



AT 947/AST 100A - Seite 27



AT 948/AST 100A - Seite 25

DELUXE  
AD



AD 801A - Seite 35



AD 801A/AST 100A - Seite 35



AD 801B - Seite 33



AD 843A - Seite 33

# ABGEBILDETE TÜREN IN DER ÜBERSICHT



AD 863D - Seite 35



AD 945/ AST100A - Seite 34



AD 945 - Seite 34



AM 132A - Seite 38



AM 132A - Seite 38



AM 131 - Seite 39



AM 134B - Seite 37



AM 156 - Seite 37



AM 170 - Seite 39



AM 170/ AST 100A - Seite 39



AC 182A - Seite 42



AC 183 - Seite 43



AC 183 - Seite 43



AC 185/ AST 185 - Seite 43

MODERN  
AM

CLASSIC  
AC



AC 190A/ AST 190 - Seite 45



AC 191/ AST 191 - Seite 44



AC 194A - Seite 44



AC 195A - Seite 42



AC 203A - Seite 41



AC 207- Seite 41



AC 209A - Seite 45



AC 209 - Seite 45

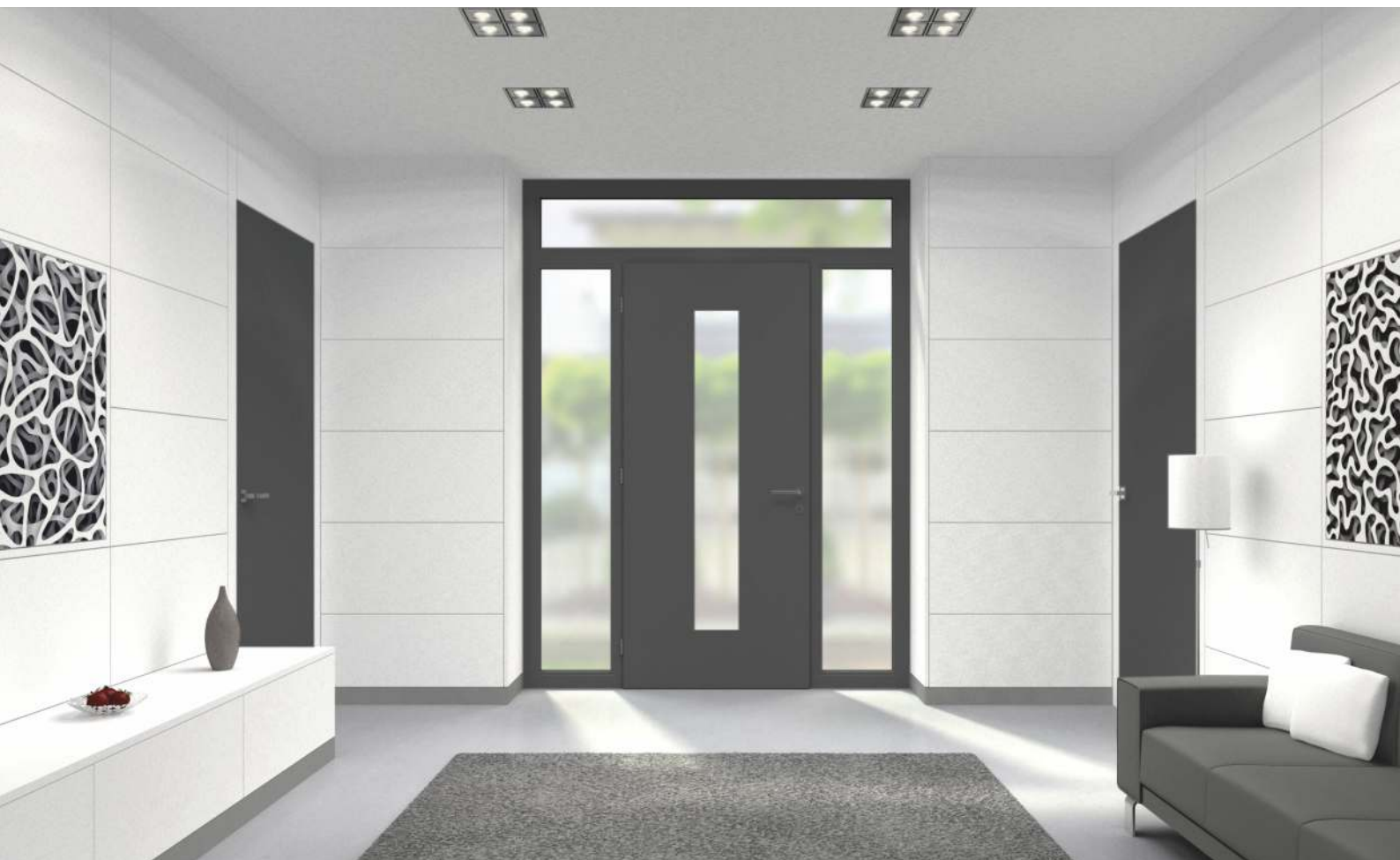

Aufgrund drucktechnischer Gegebenheiten können Farbabweichungen zwischen den Darstellungen in diesem Prospekt und den Original-Produkten auftreten.

[www.isarholz.com](http://www.isarholz.com)



Wir freuen uns, Sie persönlich zu beraten.