

ALUPROFILE

- Das Alurahmenprofil in der Stärke 75 oder 95mm mit gerader, und eckiger abgerundeter Linienführungen. ADS 75B.SI - beidseitig flächenbündige Ausführung.
- Das Alufügelprofil hat die Stärke 85 mm und 75 mm.
- In der Mitte des Rahmen- und Flügelprofils ist ein Thermokern, der die Wärmedämmcharakteristik des Profils verbessert.
- Die Füllungen sind aus hartem PUR Schaum und haben eine gute Wärmedämmcharakteristik.
- Bei den Ausführungen beidseitig flügelüberdeckend ohne Glasausschnitt wird ein Ud Wert von 0,81 W/m²K erreicht. Ein Ud Wert von 1,2 W/m²K wird bei einseitig flügelüberdeckenden Alu-Haustüren erzielt.



BESCHLAG

- Elegante Qualitätsbänder.
- Standard 5-fach Verriegelung des Flügels.
- Verschiedene Öffnungsoptionen; öffnen nach außen, öffnen mit einem Fingerprintsystem, elektrisches öffnen,

VERGLASUNG

- Zur Auswahl steht Ihnen eine breite Palette an Wärme-, Schallschutz und Sicherheitsgläsern, sowie an Ornament- und Bleiverglasungen.
- Zur Gestaltung der Gläser stehen Ihnen verschiedene Folien, sandgestrahlte Motive und andere Gestaltungsmöglichkeiten zur Verfügung.



OBERFLÄCHENBECHANDLUNG

- Eine qualitäts und umweltfreundliche Pulverbeschichtung.
- Eine große Auswahl aktueller Standardfarben.
- Zur Verfügung stehen RAL Farben matt, RAL Feinstruktur, Metallic- und einbrennlackierte Holzdekore.

ÖFFNUNG

Nach innen öffnende Türen, Ansicht von **außen**



DIN LINKS



DIN RECHTS

TYPENÜBERSICHT

Nach innen öffnende Türen, Ansicht von **innen**

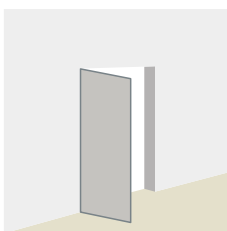

Typ 01

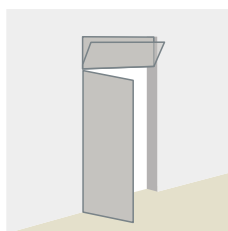

Typ 02/03

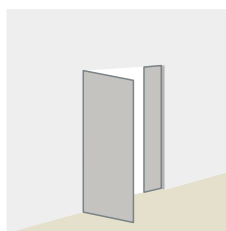

Typ 04

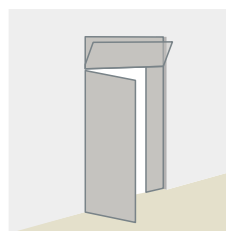

Typ 05/06

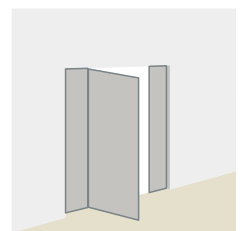

Typ 07

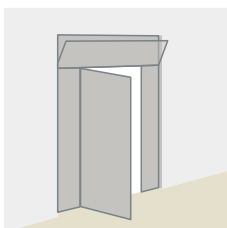

Typ 08/09

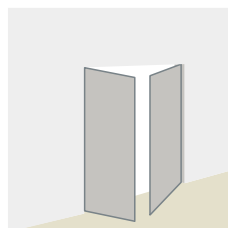

Typ 21

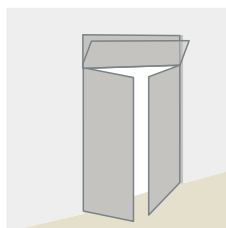

Typ 22/23

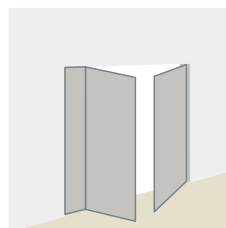

Typ 24

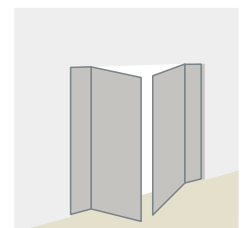

Typ 25

Aluminium Haustür **aussen**

Modell AT 100, System ADS 75B.SI

außen flächenbündig

Farbe: Flügel HD EICHE 4, querfurniert

Rahmen: RAL 7016 Fs



Holz/Alu Fenster **außen**

INO-HA80-MM flächenbündig

INO-HA80-F flächenbündig

Farbe Alu: RAL 7016 Fs

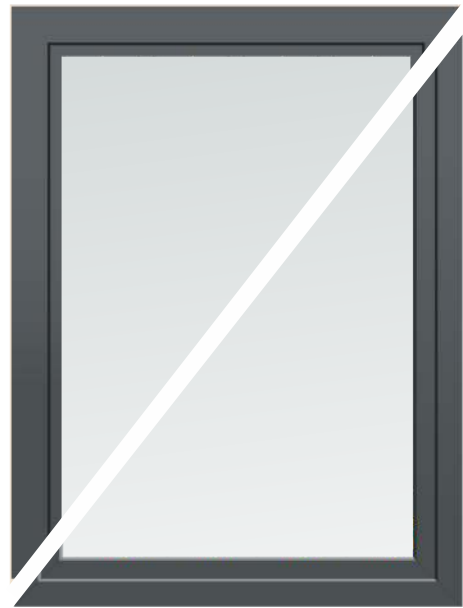

Kunststoff/Alu Fenster **außen**

Living Top Alu flächenversetzt

Farbe Alu: RAL 7016 Fs

BEDIENUNGSKOMFORT



Öffnung der Haustüre
mit dLine Fingerprint



Öffnung der Haustüre
mit Fingerprint



Griff mit integriertem
Fingerprint ARTE



Öffnung der Haustüre
mit Keypad

Aluminium Haustür innen

Modell AT 100, System ADS 75B.SI
 innen flächenbündig
 Farbe: Flügel und Rahmen: RAL 7016 Fs



Holz/Alu Fenster innen

INO-HA80-MM flächenbündig
 INO-HA80-F flächenversetzt
 Farbe Holz: RAL 7016



Kunststoff/Alu Fenster innen

Living Top Alu flächenversetzt
 Farbe Kunststoff: RAL 7016

LED LEUCHTEN



Außengriff mit integriertem Led-Leucht,
 Kratzerschutz und Edelstahl Applikation



LED-Diode

DIGITALER TÜRSPION



mit LCD - Bildschirm

SYSTEM AUSFÜHRUNGEN



ADS 95AK.SI
Eckig Rahmen

Beidseitig flügelüberdeckende Ausführung

$U_d = 0,81 \text{ W/m}^2\text{K}$
(ohne Glasausschnitt)



ADS 95.SI
Rund Rahmen

Dreifach
Verglasung

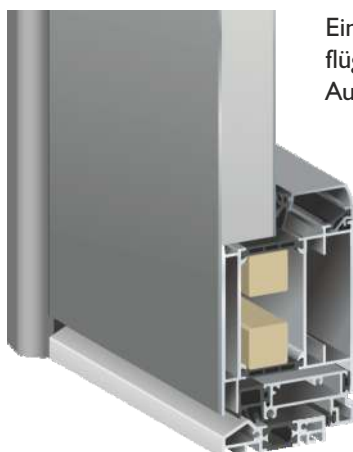

Einseitig
flügelüberdeckende
Ausführung aussen

$U_d = 1,2 \text{ W/m}^2\text{K}$
(ohne Glasausschnitt)



Ausführungen mit
sichtbarem Flügel

Bei diesen Modellen sind die Flügel sichtbar und dieses sowohl innen als auch außen. Sie sind in allen Haustürenausführungen außer in der Deluxe Serie erhältlich.



ADS 75B.SI

Innen und außen
flächenbündig

Beidseitig flügelüberdeckende Ausführung

Ud = 0,81 W/m²K

(ohne Glasausschnitt)



ADS 75.SI

außen flächenbündig

VERGLASUNGSRAHMEN AUSFÜHRUNGEN

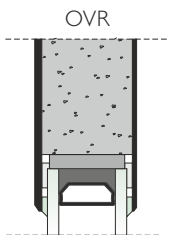

Serie TREND

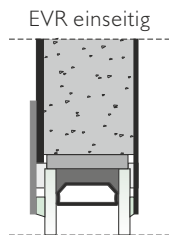

Serie DELUXE
(Standardausführung)

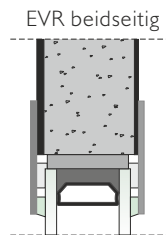

Serie DELUXE

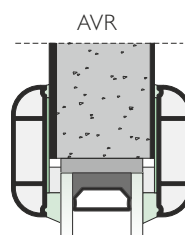

Serien MODERN, CLASSIC

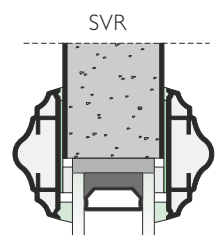

RC2 wir beraten Sie dazu gerne ausführlich.

Die Sicherheit einer Immobilie war und ist ein aktuelles Thema bei dem Kauf von Alu-Haustüren. Ergänzend zu dem in diesem Sinne hohen Qualitätsstandard der Alu-Haustüren als solches, sind diese mit **5-fach Verriegelung (Bolzen und Schwenkriegel)** als **Standardverriegelung** ausgerüstet. Des Weiteren erhalten Sie ISARHOLZ-Alu-Haustüren in den **zertifizierten Sicherheitsstufen RCI und RC2**. Darüber hinaus stehen Ihnen weitere detailrelevante Verriegelungen zur Verfügung. Für einen hohen Bedienungskomfort erhalten Sie individuelle Einrichtungen.

Über die **Sicherheitseinrichtungen für ISARHOLZ-Holz- und Holz/Alu- und Kunststoff-Haustüren** informiert Sie Ihr ISARHOLZ-Fachbetrieb.



RC2 AUSFÜHRUNG

1 SICHERUNGSBOLZEN



2 SICHERHEITSGLAS P4A



3 FALZLUFTBEGRENZER



4 SICHERHEITSPROFILZYLINDER MIT ANBOHRSCHUTZ

5 SICHERHEITSGARNITUR



3 DREITEILIGES TÜRBÄNDER



Serienmäßig bis Türhöhe 2150 mm mit 3 Bänder und ab 2151 mm mit 4 Bänder gefertigt (standard)

4 TÜRSCHWELLEN

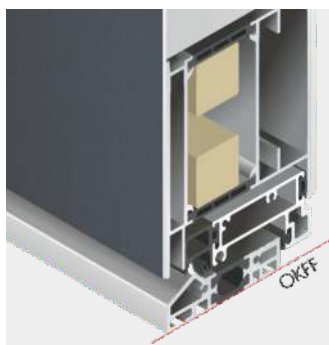

FPI (standard)

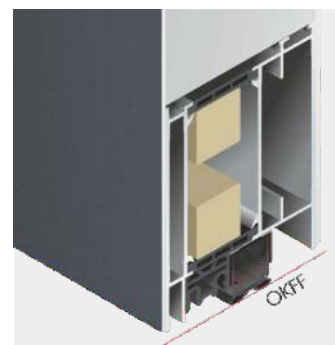

FP5 automatische Türabdichtung

SICHERHEITSTÜRVERSCHLÜßE



ATVE 5
5-fach Verriegelung
 - Edelstahl
 mit Bolzen und
 Schwenkriegel

**Serienmäßige
 Sicherheit**

- mechanische
 Mehrfachverriegelung

- 5-fach Schutz durch
 einen Hauptriegel,
 2 Bolzen und
 2 Schwenkriegel



ATVK 5
**5-fach Verriegelung
 mit Komfortfunktion**
 - Edelstahl,
 mit Bolzen und
 Schwenkriegel

- Mechanisch Öffnen der Tür
 über Drücker immer möglich
 (Komfortöffnung)
- Ein Freilaufzylinder oder ein
 Knaufzylinder erforderlich
- Möglich nur in der Kombination
 außen Stoßgriff - innen Drücker
 (Drücker außenseitig nicht
 möglich)

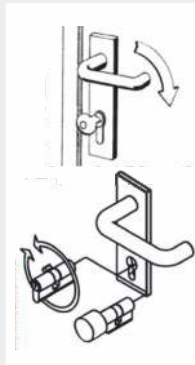

Komfortfunktion
 = Schnellöffnung
 von innen über
 den Drücker

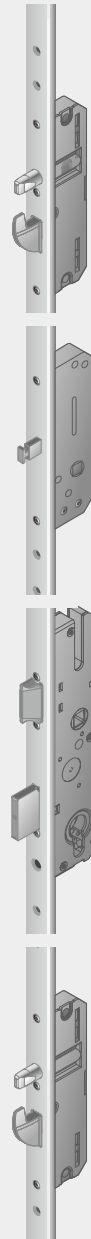

ATVS 5
5-fach Verriegelung
 - Edelstahl
 mit Bolzen,
 Schwenkriegel
 und **Türfänger**

Der spezialgehärtete Sperrbügel
 sorgt dafür, dass sich die Tür
 nur einen Spalt breit öffnet, sodass
 sich kein ungebetener Gast zwischen
 Tür und Stock durchzwängen kann.

Von innen lässt sich das Fängerschloss
 einfach über einen Drehknopf
 bedienen, von außen wird es mit dem
 Schlüssel über das Hauptschloss
 betätigt.



ELEKTRO-TÜRÖFFNER



VERDECKTLIEGENDE TÜRBÄNDER



Für nach innen öffnende
 Türen - 100° Öffnungswinkel



Für nach außen öffnende
 Türen und ADS 75B.SI - 180°



ATVE A
5-fach Sicherheits-
türverschuß
AUTOMATIK,
MECHANISCH

- die selbstverriegelnden Fallenriegel
- die 4 Fallenriegel beim Zuziehen der Türe automatisch 20 mm vorschießen und gegen ein Zurückdrücken gesichert sind.
- durch zusätzliches manuelles Verriegeln wird der Riegel des Hauptschlösses vorgeschlossen und der Türdrücker blockiert.

ATVE A-M
5-fach Sicherheits-
türverschuß
AUTOMATIK,
mit motorischer
Funktion,
inkl. Netzteil

- Verriegelungselemente lassen sich mechanisch verriegeln
- Entriegelung über die Rücksprechanlage, Biometrie, ... (der Riegel des Hauptschlösses darf nicht vorgeschlossen sein)

ATVS 5EAF
5-fach Verriegelung

-Edelstah + Ekey,
inkl. Netzteil mit elektromechanischem Antrieb, Fingerscann und Freilauf-Profilzylinder mit Aufbohrschutz und Gefahrenfunktion einschließlich 6 Schlüsseln

Sobald die Tür geschlossen ist, erfolgt im Nachtbetrieb eine automatische Verriegelung durch den Motor (ca. 3 sec.). Alle vorhandenen Verschlusselemente werden herausgefahren.
Die Tür kann manuell durch den Zylinderschlüssel oder automatisch über ein externes Zutrittskontrollsystem entriegelt werden.
Wenn die Tür vollständig verriegelt ist, ist es auch möglich, von innen über den Drücker alle Riegelemente zurückzufahren und die Tür so schnell zu öffnen.



dLine



Ekey in Schwarz Farbe



Ekey

ATVS 5EAFI
5-fach Verriegelung

-Edelstah + IDENCOM,
inkl. Netzteil mit elektromechanischem Antrieb, Fingerscann und Freilauf-Profilzylinder mit Aufbohrschutz und Gefahrenfunktion einschließlich 6 Schlüsseln



Idencom

PROFILZYLINDER



Profilzylinder mit Not- und Gefahrenfunktion und 6 Schlüsseln (standard)



Profilzylinder mit Aufbohrschutz und 6 Schlüsseln



Freilauf-Profilzylinder mit Aufbohrschutz und Gefahrenfunktion einschließlich 6 Schlüsseln



Aluminium Haustür **aussen**

Modell AT 862A, System ADS95AK.SI

Farbe: Cast Iron Fs Metallic

HAUSNUMMER MOTIVGLAS



TÜRSPION



Messing poliert / Satin Chrom

AUSSEN RUNDROSETTE



Edelstahl
(standard)

schwarz



WETTERSCHENKEL



Briefkasten-Systeme



WSE 03 als Edelstahl Applikation



WSE 01 aus Edelstahl



WSE 02 aus Edelstahl ohne Löcher

Aluminium Haustür innen

Modell AT 862A, System ADS95AK.SI
 Farbe: Ral 9016

Türschließer TS 5000



INNENGRIFFE, INNENROSETTE

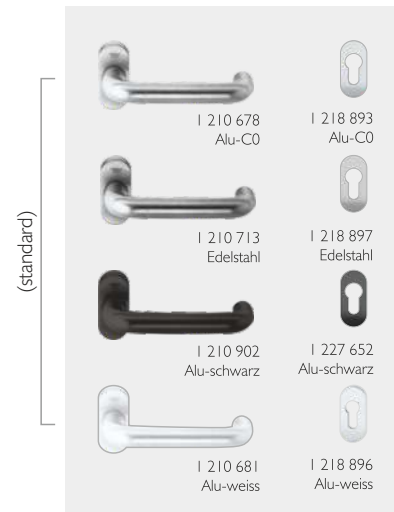
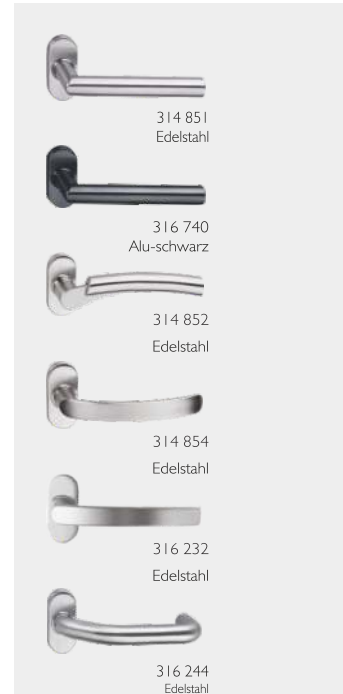

Dreiteilige Rolltürbänder, Innengriffe und Innenrosetten farblich aufeinander abgestimmt

AUßENGRIFFE

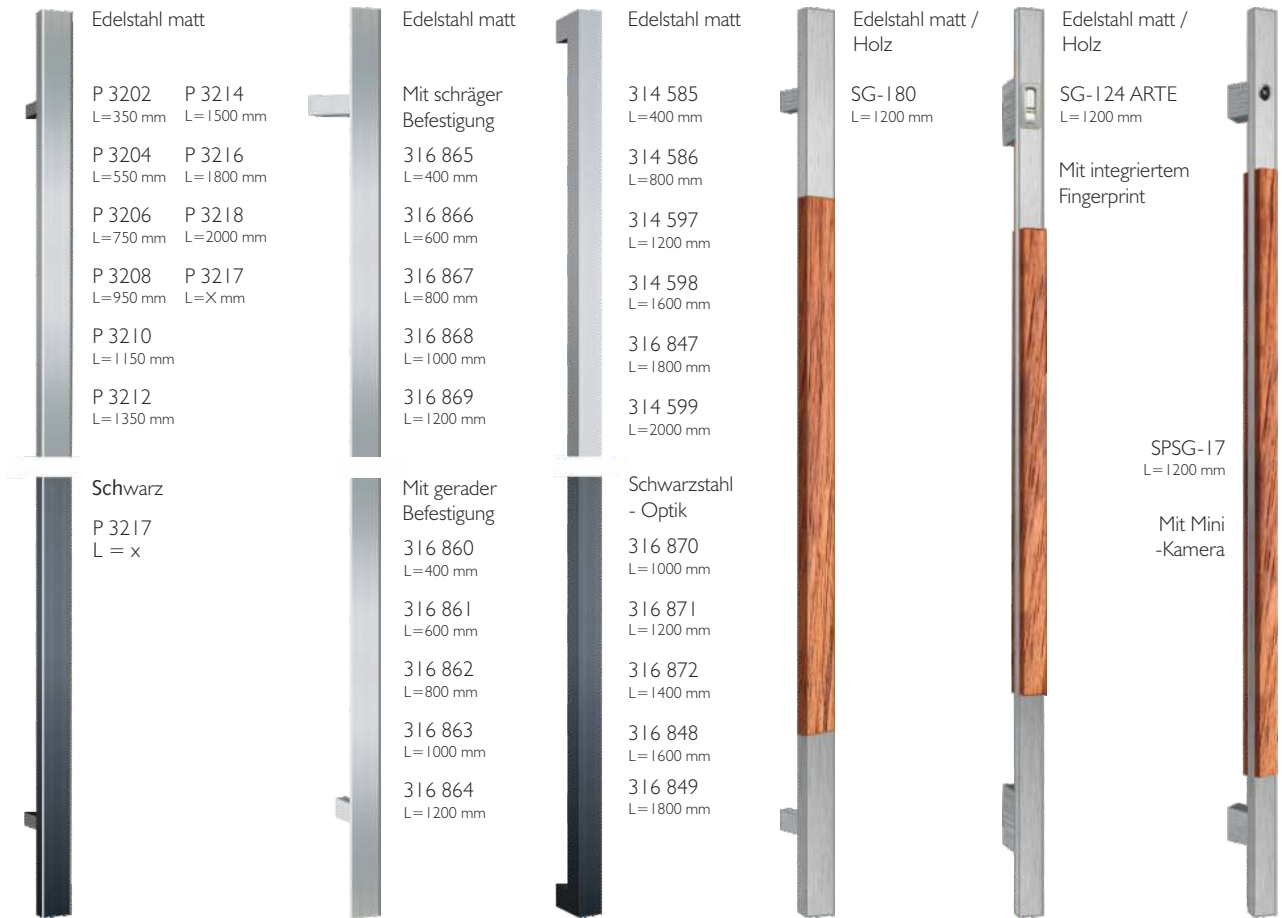

AUßENROSETTE



KRATZERSCHUTZ



Mit integriertem Fingerprint

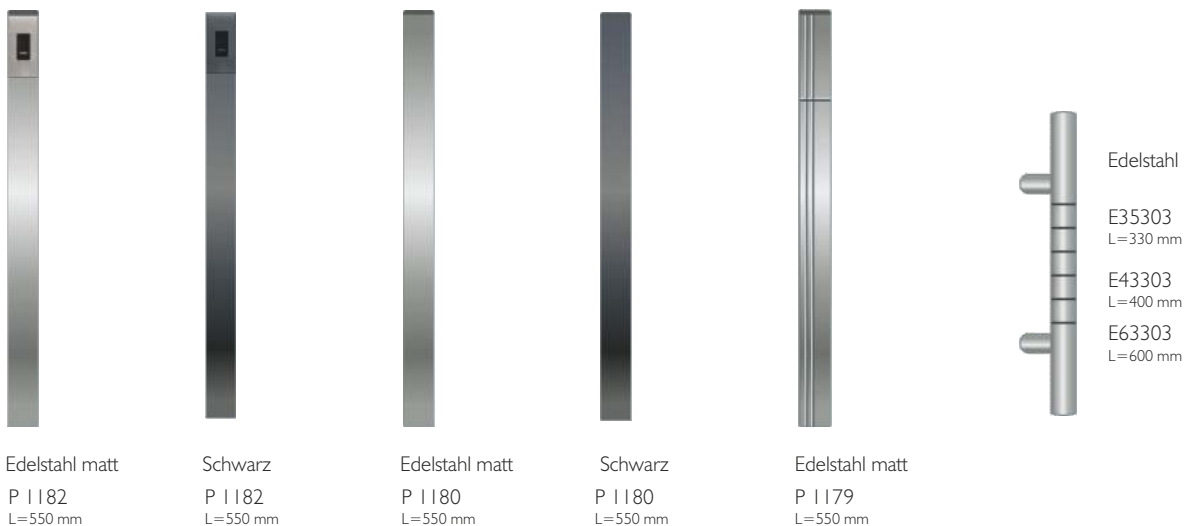



Edelstahl matt/
Beton-Optik

SSG-300
-I200 Niro
L=1200 mm

Edelstahl matt

Mit schräger
oder gerader
Befestigung

TG 50
L=500 mm

TG 60
L=600 mm

TG 80
L=800 mm

TG 100
L=1000 mm

TG 120
L=1200 mm

TG 140
L=1400 mm

TG 160
L=1600 mm

TG 180
L=1800 mm



Edelstahl matt

P2/2
l=550 mm

P2/4
l=950 mm

P2/6
l=1350 mm

P2/7
l=1500 mm

Mit Beleuchtung

P2/7-schwarz
l=1500 mm

Mit Beleuchtung



Edelstahl matt

F5/2
L=550 mm

F5/4
L=950 mm

F5/6
L=1350 mm

F5/7
L=1500 mm

Mit Beleuchtung

F5/7 - schwarz
L=1500 mm

Mit Beleuchtung



Edelstahl matt /
Jatoba Holz

SG-I34-I600
L=1600 mm







Edelstahl matt

ZAE 66
L = x

ZAE 66
schwarz
L = x

LED-DIODEN, Licht farbe weiß, Led-Diodelampe Edelstahl

-  L 1 (57 x 57 mm)
-  L 2 (Ø=41 mm)
-  L 4 (Ø=35 mm)
-  L 3 (Ø=60 mm)
-  L 5 (Ø=30 mm)



Robusta Gold
314 543
L=250 mm



Brüniert
314 544
L=250 mm



Messing poliert
284 744
L=330 mm



Edelstahl matt
284 487
L=380 mm



Edelstahl matt
ZAE 66R
L=X mm



Edelstahl matt
P 1176
L=380 mm



Edelstahl matt
P 1177
L=380 mm

STOßGRIFFE



SG-48



SG-79



SG-49



SG-83



SG-77

GRIFFSCHALEN



GS-11



GS-21



GS-20



GS-88



GS-74

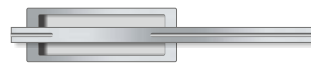

GS-113

V 107
L=1400 mm



INTEGRIERTE GRIFFLEISTE



J 137 flächenbündig

integrierte Griffleiste - Ral farbe;
sichtbarer Schlitz = 45mm
Länge in mm nach Wunsch

TÜRKLOPFER



253 942

Messing- matt verchromt



253 944

Messing- poliert schutzlackiert

NAMENSSCHILD



NSE I
Edelstahl



255 506
Messing poliert



255 510
Messing poliert

SICHERHEITS-DRÜCKERGARNITUR



314 866



314 863



316 242



316 668



316 662



316 680

ORNAMENTGLÄSER

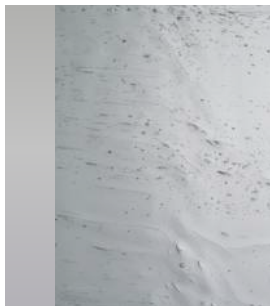

Altddeutsch weiss



Chinchilla weiss

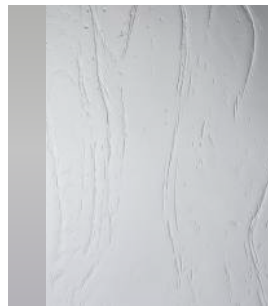

Gothic weiss

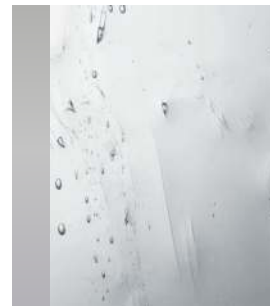

Altddeutsch K weiss

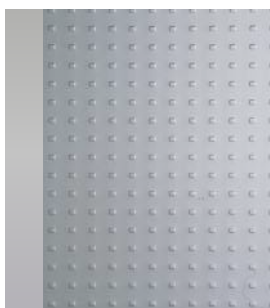

Mastercarre weiss



Masterligne weiss

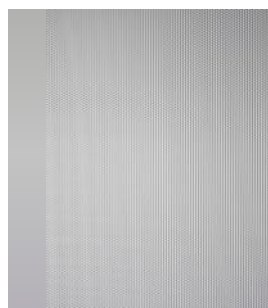

Masterpoint weiss



Satinato weiss

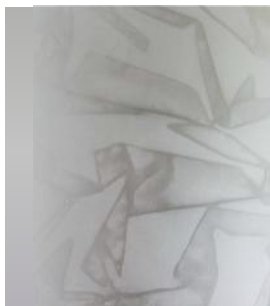

Silk weiss

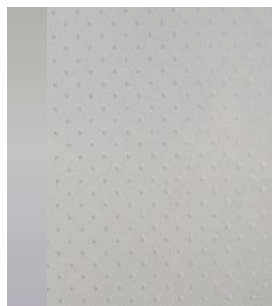

Pave weiss

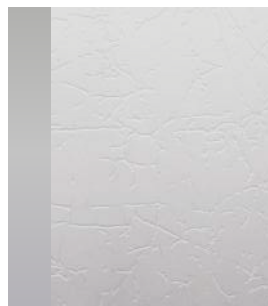

Uadi weiss



Nebulosa weiss

WÄRMESCHUTZGLAS

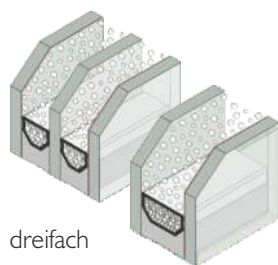

dreifach

zweifach

SANDGESTRAHLTE
MOTIVE



GLAS MIT
APPLIKATIONEN



BLEIVERGLASUNG
MOTIVE



FARBGESTALTUNGEN

Vielfältige Farbgestaltungen für die Alu-Oberflächen
Auszug

MASTER COLLECTION

(feinstruktur, metallic)



Night Grey
Feinstruktur Metallic



Cast Iron
Feinstruktur Metallic



Russet Copper
Feinstruktur Metallic



Brown
Feinstruktur Metallic



Verdigris
Feinstruktur Metallic



Granit Nature
Feinstruktur Metallic



Volcanic Ash
Feinstruktur Metallic



Elves Bench
Feinstruktur Metallic

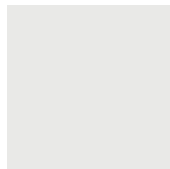

Artic Ice
Feinstruktur Metallic



Precious Sand
Feinstruktur Metallic



Iceberg Blue
Feinstruktur Metallic



Rumbling Sky
Feinstruktur Metallic

ANODIZING COLLECTION

(matt, metallic)

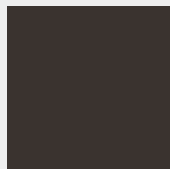

CARBON NIGHT
Matt Metallic



DARK COPPER
Matt Metallic



SIMPLY COPPER
Matt Metallic



GREY BD
Matt Metallic

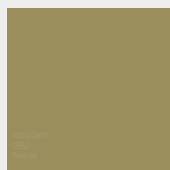

GSPED 2
Matt



GSPED 3
Matt



GSPED 4
Matt



NOBLE BRONZE
Matt Metallic

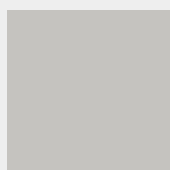

GSPED 0
Matt

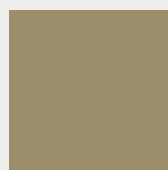

GSPED 1
Matt



ORIGINAL PLATINIUM
Matt Metallic

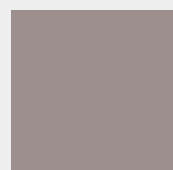

SILVER DREAM
Matt Metallic

STEINDEKOR

NEU



Dekor Zement hell



Dekor Beton dunkel

HOLZDEKOR

NEU



Dekor Altholz



Dekor Stadelholz grau

RAL FARBEN

(matt, feinstruktur, metallic, glatt)

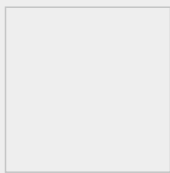

RAL 9016
Matt/ Feinstruktur

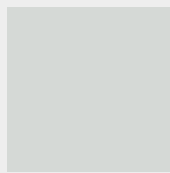

RAL 7035
Matt/ Feinstruktur

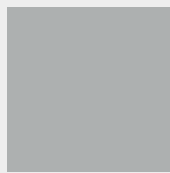

RAL 7004
Matt/ Feinstruktur



RAL 7016
Matt/ Feinstruktur

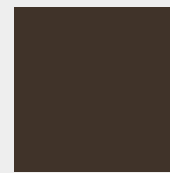

6768 BRAUN
Feinstruktur

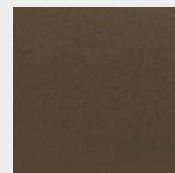

Rostiges eisen
Feinstruktur

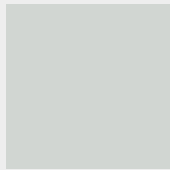

RAL 9006
Metallic glatt



RAL 9007
Metallic glatt

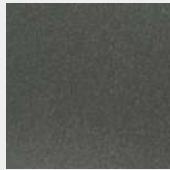

DB 703
Metallic glatt



DB 703
Metallic Feinstruktur



RAL 8017
Matt/ Feinstruktur



RAL 5014
Matt/ Feinstruktur



RAL 5014
Matt/ Feinstruktur

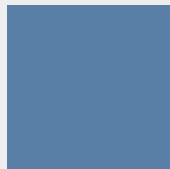

RAL 5007
Matt/ Feinstruktur

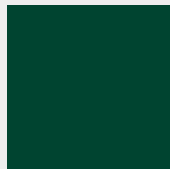

RAL 6005
Matt/ Feinstruktur



RAL 8001
Matt/ Feinstruktur



RAL 8003
Matt/ Feinstruktur

Holzdekor (struktur)



Douglas 2



Douglas 6



Douglas 7



Eiche dunkel



Kirsch 2

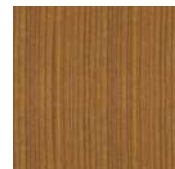

Kirsch 3

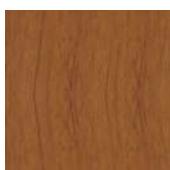

Eiche 4

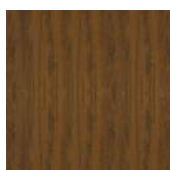

Eiche 2

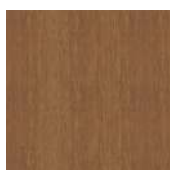

Golden Oak

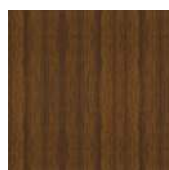

Nuss 1

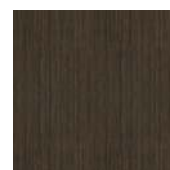

Wenge

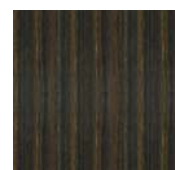

Walnuss dunkel

ABGEBILDETE TÜREN IN DER ÜBERSICHT

TREND
AT



AT 100A/AST 100A - Seite 19



AT 101 - Seite 19



AT 102 - Seite 19



AT 100/AST 100A - Seite 8



AT 100 - Seite 7



AT 100 - Seite 7



AT 100 - Seite 9



AT 100/AST 100A - Seite 9



AT 110 - Seite 13



AT 121 - Seite 13



AT 123 - Seite 8



AT 131 - Seite 34



AT 137 - Seite 40



AT 153A - Seite 43



AT 255/AST 255 - Seite 41



AT 258A - Seite 36



AT 264 - Seite 11



AT 264A/AST 264A - Seite 11



AT 265/AST 265 - Seite 10



AT 265A - Seite 10



AT 266 - Seite 12



AT 266A - Seite 12



AT 267 - Seite 40



AT 806/AST 806 - Seite 26



AT 810/AST 100A - Seite 25



AT 843/AST 100A - Seite 28



AT 845/AST 845 - Seite 16



AT 862A/AST 862A - Seite 21



AT 863A/AST 863A - Seite 32



AT 863B - Seite 32



AT 863C - Seite 33



AT 864/AST 864 - Seite 37



AT 866B/AST 866B - Seite 29



AT 867 - Seite 18



AT 867/AST 867 - Seite 18



AT 872 - Seite 28



AT 875A - Seite 34



AT 875B - Seite 35



AT 881A - Seite 43



AT 883/AST 883 - Seite 43



AT 885 - Seite 42



AT 885A/AST 885A - Seite 42



AT 887 - Seite 44



AT 887B - Seite 45

ABGEBILDETE TÜREN IN DER ÜBERSICHT



AT 887D - Seite 44



AT 887E/AST 887E - Seite 45



AT 889A - Seite 41



AT 891 - Seite 37



AT 891A - Seite 37



AT 893 - Seite 36



AT 894 - Seite 23



AT 901 - Seite 29



AT 904 - Seite 39



AT 906 - Seite 20



AT 906A - Seite 21



AT 907 - Seite 17



AT 907A - Seite 15



AT 907B - Seite 15



AT 909/AST 909 - Seite 24



AT 911/AST 911 - Seite 17



AT 919 - Seite 16



AT 920 - Seite 23



AT 924A/AST 924A - Seite 27

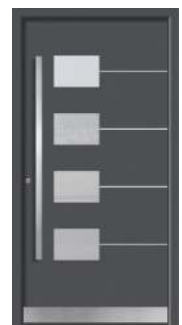

AT 934 - Seite 31



AT 934A - Seite 31



AT 941A - Seite 20



AT 943 - Seite 39



AT 944 - Seite 25



AT 945A - Seite 24



AT 946A- Seite 26



AT 946B - Seite 27



AT 947/AST 947 - Seite 33



AT 948/AST 948 - Seite 35

DELUXE
AD



AD 168/AST 168 - Seite 51



AD 801A/AST 801 - Seite 49



AD 802A - Seite 50



AD 843A - Seite 47



AD 852A - Seite 49



AD 863D - Seite 47



AD 875C - Seite 50



AD 923 - Seite 51



AD 945 - Seite 48



AD 945A/AST 945 - Seite 48

MODERN
AM



AM 131 - Seite 56



AM 132A - Seite 54



AM 133A - Seite 57



AM 134B - Seite 55



AM 156 - Seite 57



AM 170 - Seite 58



AM 172C - Seite 55



AM 180 - Seite 59

ABGEBILDETE TÜREN IN DER ÜBERSICHT



AM 181 - Seite 58



AM 222 - Seite 59



AM 863D - Seite 53



AM 863D - Seite 53



AM 875C - Seite 56



AM 945A - Seite 54

CLASSIC
AC

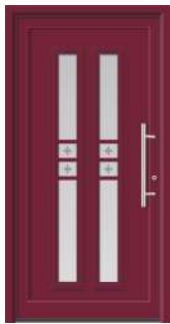

AC 173



AC 178



AC 182 - Seite 61



AC 182A - Seite 62



AC 183 - Seite 65



AC 184 - Seite 62



AC 185/AST 185 - Seite 63



AC 186 - Seite 63



AC 188



AC 190



AC 190A/AST 190 - Seite 65



AC 191/AST 191 - Seite 64



AC 192 - Seite 64



AC 194



AC 194A - Seite 66



AC 195



AC 195A - Seite 67



AC 198



AC 201



AC 202/AST 202



AC 203A - Seite 65



AC 206 - Seite 66



AC 207 - Seite 61



AC 208



AC 209



AC 209A - Seite 67



AC 210



AC 213



AC 218



AC 545

Aufgrund drucktechnischer Gegebenheiten können Farbabweichungen zwischen den Darstellungen in diesem Prospekt und den Original-Produkten auftreten.

Technische Änderungen, Satz- und Druckerfehler vorbehalten.



www.isarholz.com

Wir freuen uns, Sie
persönlich zu beraten

