

HOLZ-HOLZ/ALUMINIUM-HAUSTÜREN

## QUALITÄTSINFO

### HOLZ

- Holzarten: Fichte, Kiefer, Lärche, Eiche und Meranti.
- Das verwendete Holz entspricht der Qualitätsanforderung nach Standard EN 942.
- Die Holzfeuchtigkeit ist kontrolliert und beträgt  $13 \pm 2\%$ .  
Eingearbeitete Aluminiumprofile erhöhen die Stabilität des Flügels und verhindern das Verwinden.

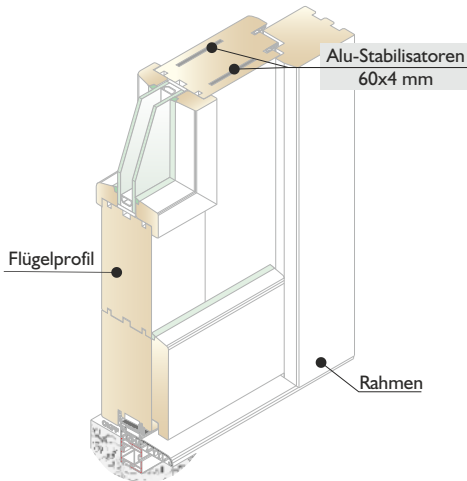

### HOLZPROFILE

- Rahmenstärke 68, 80 und verschiedene Flügelstärken.
- Profile sind mit einem wasserbeständigen Leim der Gruppe D4 nach EN 204 und pr EN 14257 dreischichtverleimt.

### BESCHLAG

- Dreidimensional verstellbare Standardbänder Baka Protect 4010 3D FD (HH 68) und verdeckt liegendes Bänder Tectus TE 540 3D (HH 80)
- 3 oder 5-fache Verriegelung.
- Verschiedene Öffnungsoptionen; Öffnen nach außen, Öffnen mit einem Fingerprintsystem, elektrisches Öffnen, .....

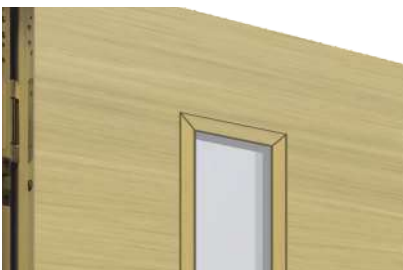

### VERGLASUNG

- Zur Auswahl steht Ihnen eine breite Palette an Wärme-, Schallschutz und Sicherheitsgläsern, sowie an Ornament- und Bleiverglasungen.
- Zur Gestaltung der Gläser stehen Ihnen verschiedene Folien, sandgestrahlte Motive und andere Gestaltungsmöglichkeiten zur Verfügung.

### 3-Fach Farbaufbau

- Zunächst wird durch eine spezielle Grundierung das Holz gegen Insekten und Pilzen geschützt.
- Mit der Zwischenbeschichtung werden die Poren des Holzes geschützt und die Oberfläche wird dadurch glatt und gleichmäßig.
- Durch die elektronische Endbehandlung wird eine gleichmäßige Beschichtung der gesamten Oberfläche, die Witterungsbeständigkeit und die Eleganz der ISARHOLZ-Haustüren erreicht.
- Möglich zweifarbige Ausführungen, auch innen und außen.



ÖFFNUNG

Nach innen öffnende Türen, Ansicht von **außen**



DIN LINKS



DIN RECHTS

TYPENÜBERSICHT

Nach innen öffnende Türen, Ansicht von **innen**

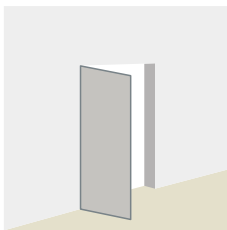

Typ 01

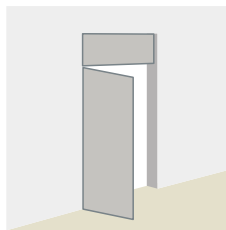

Typ 02

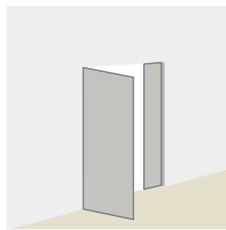

Typ 04

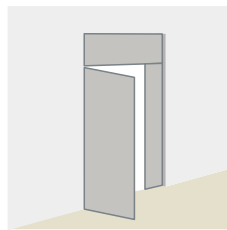

Typ 05

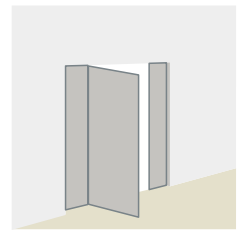

Typ 07

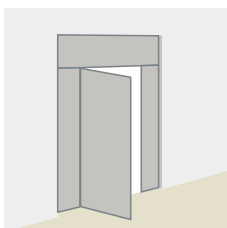

Typ 08

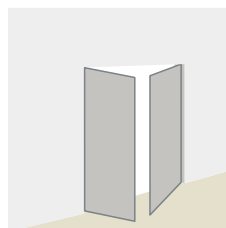

Typ 21

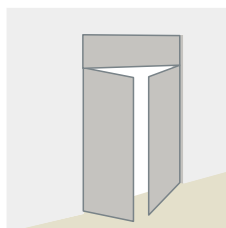

Typ 22

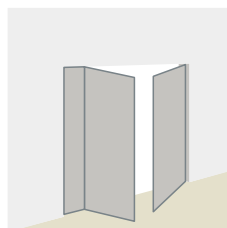

Typ 24

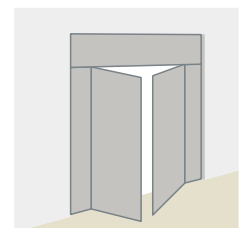

Typ 25

## Holz Haustür **außen**

Modell HTR 106B, Stärke 68/95 mm  
**außen flächenbündig**  
 Holz und Farbe: Flügel Eiche RE 200  
 Rahmen Ral 7016



## Holz/Alu Fenster **außen**

INO-HA80-MM **flächenbündig**  
 INO-HA80-ML **flächenbündig**  
 INO-HA80-F **flächenbündig**  
 Farbe Alu: RAL 7016 Fs



## Holz Fenster **außen**

INO-92 flächenversetzt  
 INO-80 flächenversetzt  
 Holz und Farbe: Eiche RE 200

## BEDIENUNGSKOMFORT



Öffnung der Haustüre  
mit dLine Fingerprint



Griff mit integriertem  
dLine Fingerprint



Öffnung der Haustüre  
mit Idencom Fingerprint



Öffnung der Haustüre  
mit Keypad



## Holz Haustür innen

Modell HTR 106B, Stärke 68/ 95 mm  
innen flächenversetzt  
Holz und Farbe: Eiche RE 200



## Holz/Alu Fenster innen

INO-HA80-MM flächenbündig  
INO-HA80-ML flächenbündig  
INO-HA80-F flächenversetzt  
Holz und Farbe: Eiche RE 200



## Holz Fenster innen

INO-92 flächenversetzt  
INO-80 flächenversetzt  
Holz und Farbe: Eiche RE 200

## LED LEUCHTEN



Außengriff mit integriertem  
Led-Leucht



LED-Diode

## TÜRSPION

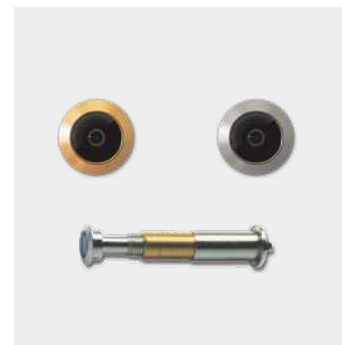

Messing poliert / Satin Chrom

HOLZ/ALU HAUSTÜREN KOLLEKTION **INO-HAH**

mit Aluminium Schalen

Holz- Stärke **80** mm

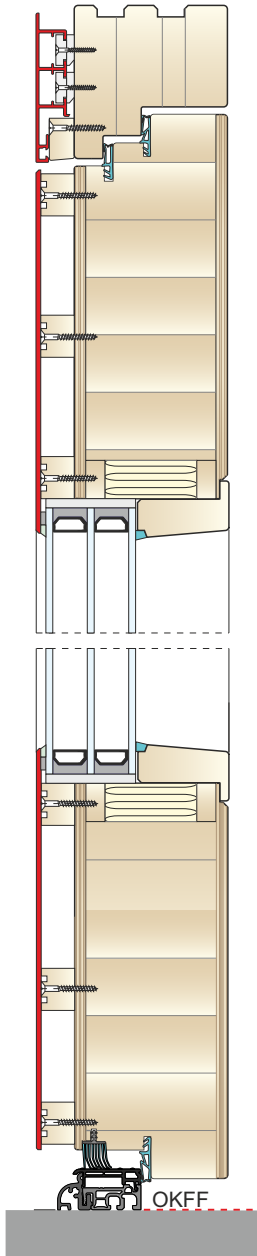

Serie **TREND ALPHA**

mit Aluminium Schalen

Holz- Stärke 68 mm

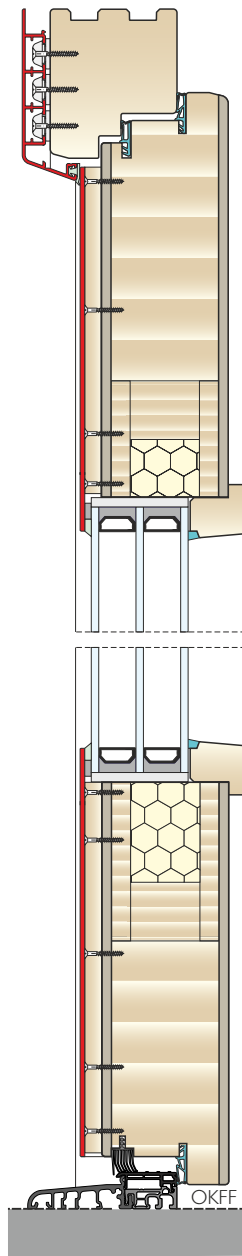

Serie **TREND MODERN**

mit Aluminium Schalen

Holz- Stärke 68 mm

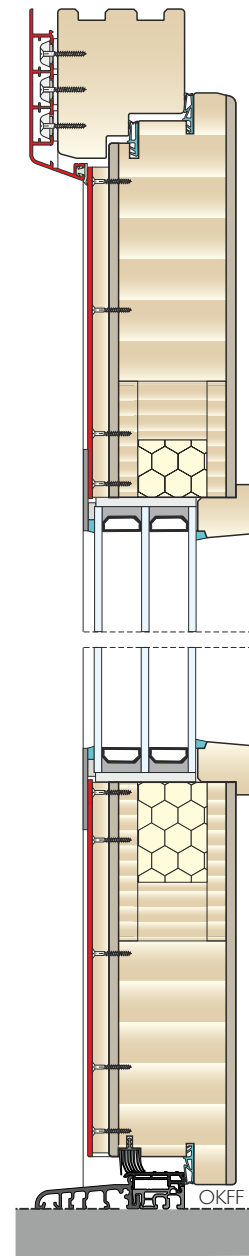

Serie **DELUXE**

Holz-Stärke 68 mm	<p>STANDARDAUSFÜHRUNG <b>KANTIGE</b> Glasleiste</p>	<p>ALTERNATIVAUSFÜHRUNG <b>PROFILIERTE</b> Glasleiste</p>	<p>ALTERNATIVAUSFÜHRUNG <b>SOFT</b> Glasleiste</p>

HOLZHAUSTÜREN KOLLEKTION INO-HH

Blendrahmen mit Alu-Schale

Stärke 80/ 80 mm

Stärke 80/ 80 mm

Stärke 68/ 95 mm

Holz- Stärke 68/ 95 mm

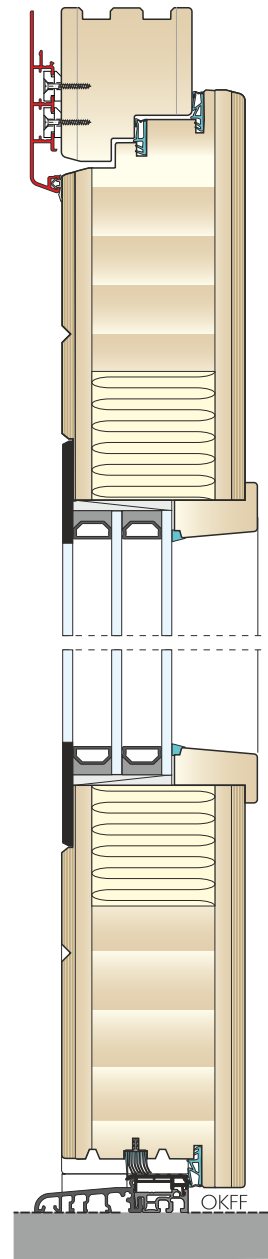
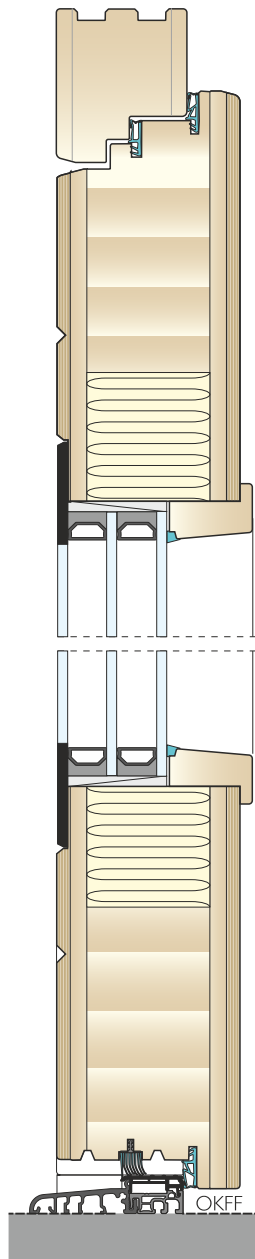
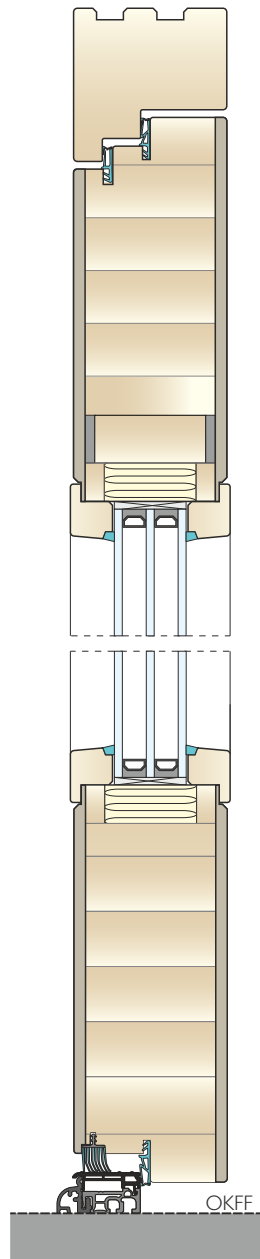
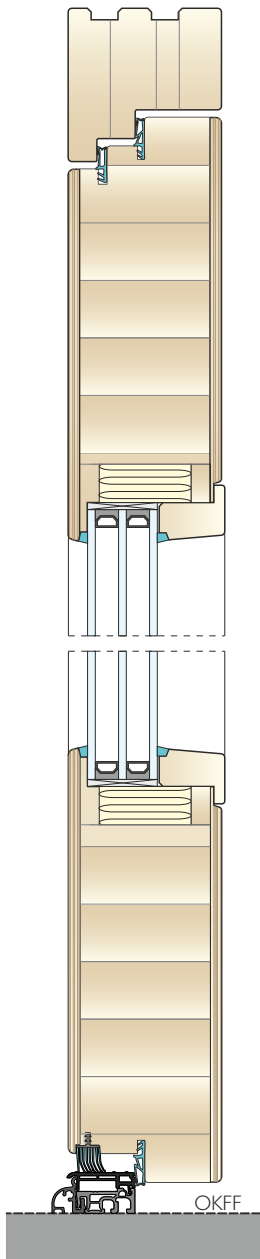

Serie TREND ALPHA

Serie TREND NOVO

Serie TREND RUSTICO

Serie TREND RUSTICO

HOLZHAUSTÜREN KOLLEKTION **INO-HH**

Stärke 68/ 68-95 mm

Stärke 68/ 68 mm

Stärke 68/ 68 mm

Stärke 68/ 68 mm

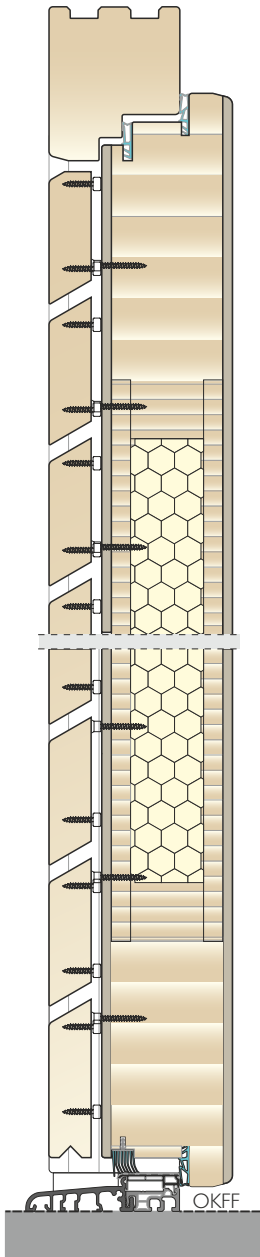

Serie **TREND LINE**

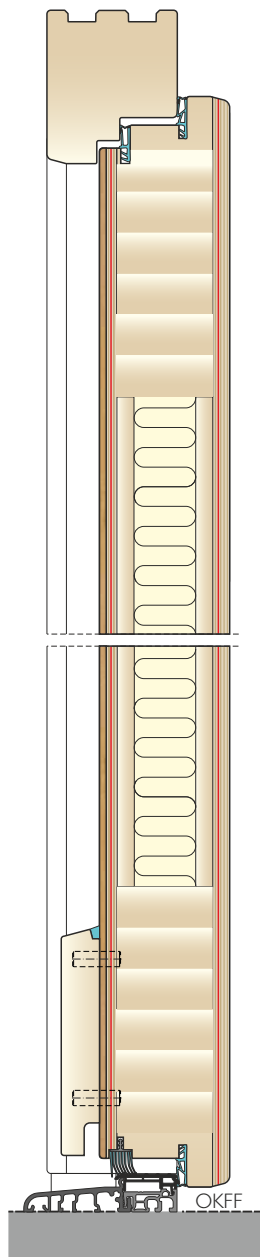

Serie **TREND HBF**

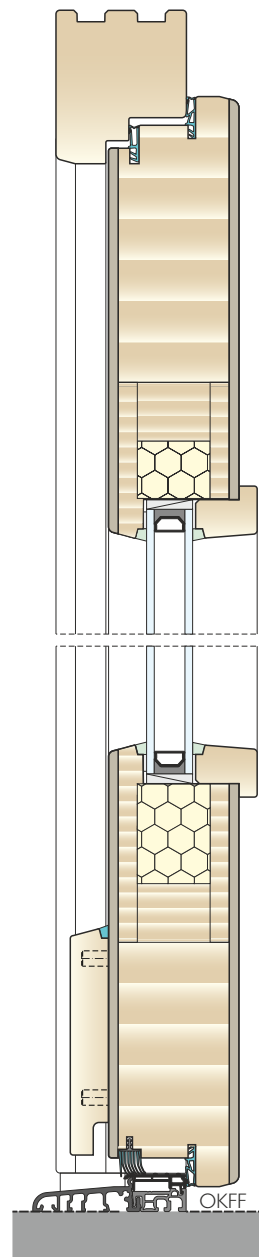

Serie **TREND**

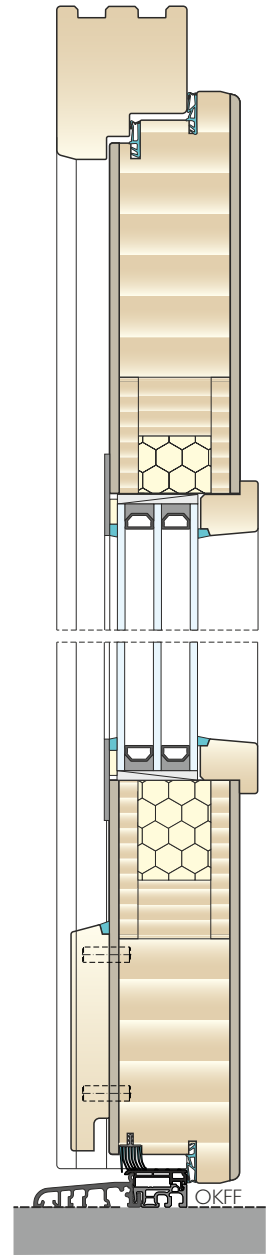

Serie **DELUXE**



HOLZHAUSTÜREN KOLLEKTION **INO-HH**

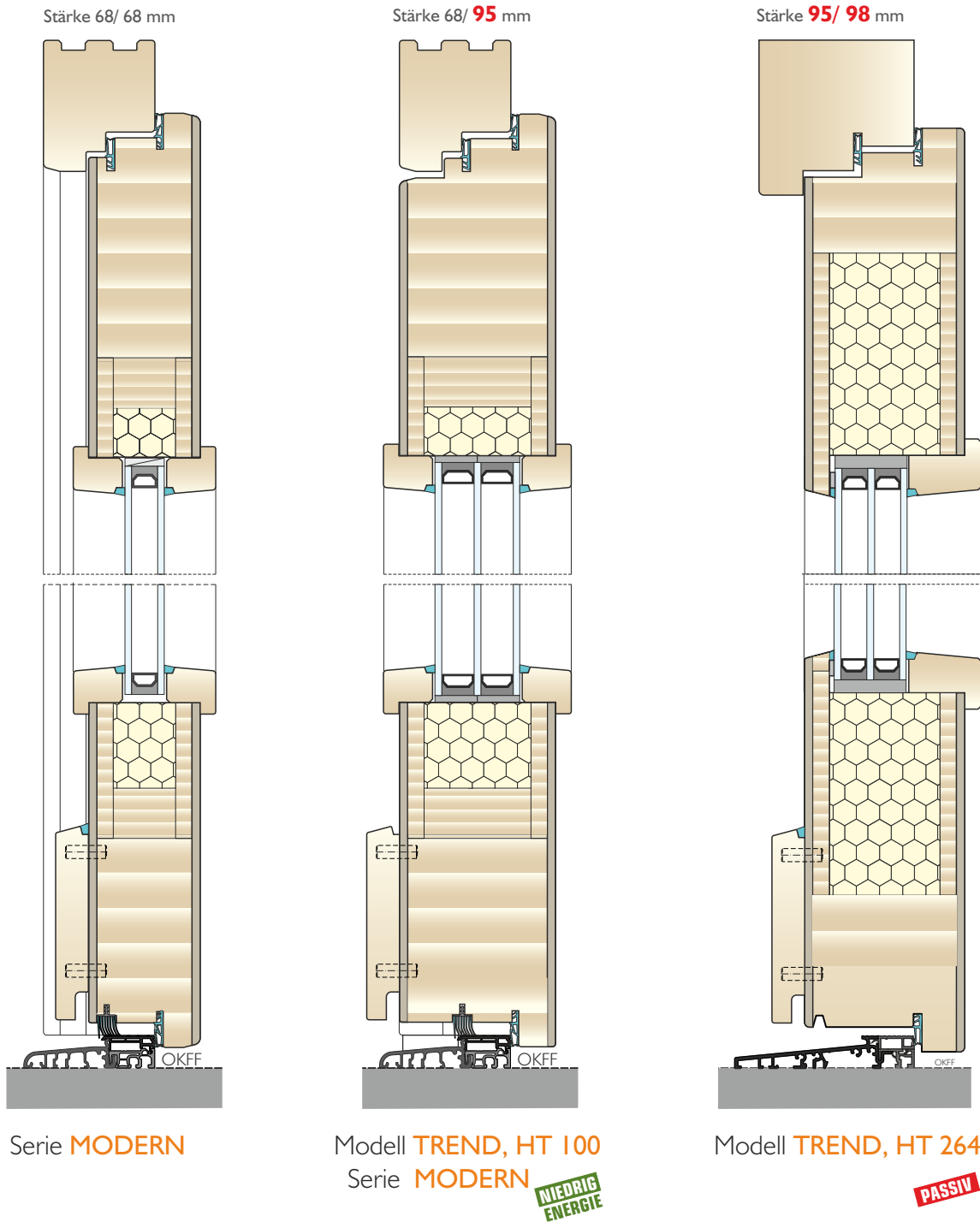

HOLZ/ALU HAUSTÜREN  
KOLLEKTION **INO-HAH**

Massiv Holz  
Holz- Stärke 68 mm

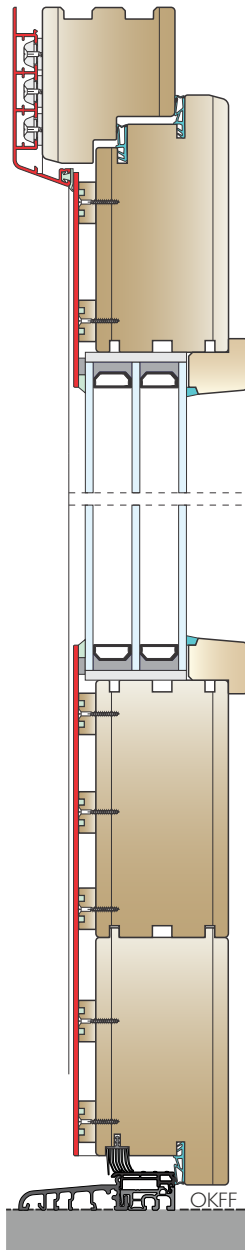

Serie **KLASSICO**  
(Aus technischen Gründen  
sind nicht alle Modelle lieferbar.)

HOLZHAUSTÜREN  
KOLLEKTION **INO-HH**

Massiv Holz  
Stärke **80/ 80** mm

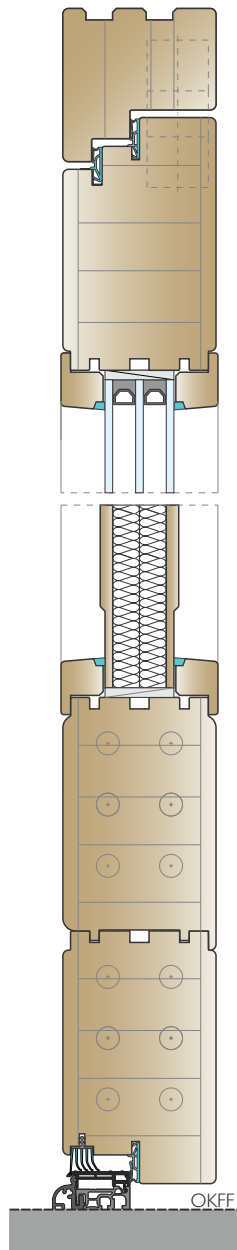

Serie **KLASSICO ETA**

Massiv Holz  
Stärke 68/ 68 mm

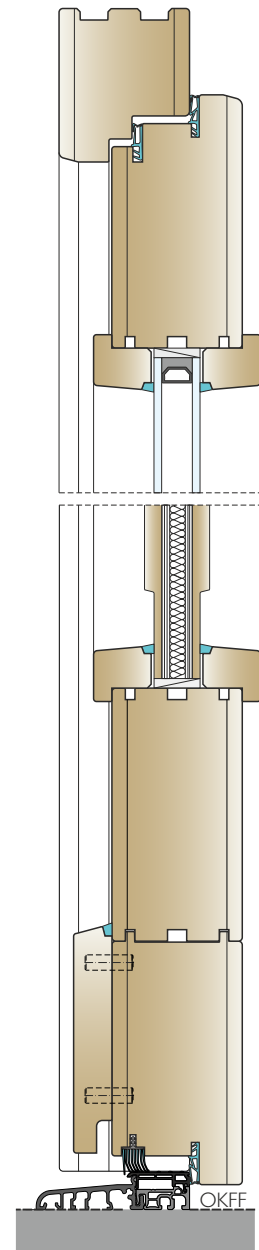

Serie **ANTICO,  
RUSTICO, KLASSICO,  
NEOKLASSICO**

HOLZHAUSTÜREN KOLLEKTION **INO-HH**

STANDARDAUSFÜHRUNG **HH 68**  
**KANTIGE** (Glasleiste, Wetterschenkel)  
**BKV 80 TB** Bodenprofil

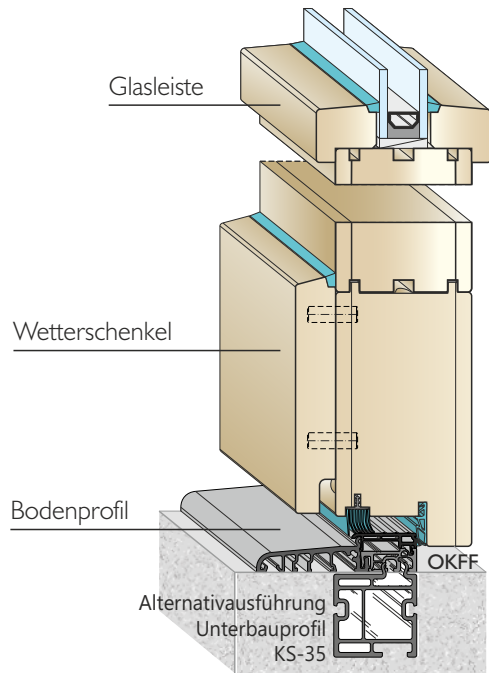

STANDARDAUSFÜHRUNG **HH 80**  
**BKV 40 TB** Bodenprofil

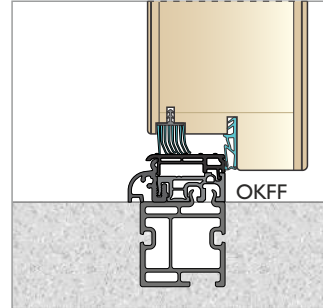

ALTERNATIVAUSFÜHRUNG **HH 80**  
**BKV 80 TB** Bodenprofil

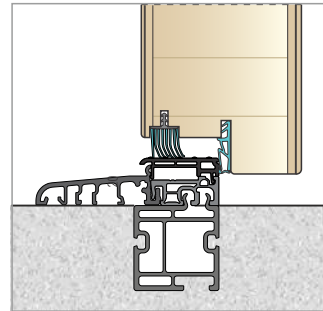

ALTERNATIVAUSFÜHRUNG  
**PROFILIERTE** (Glasleisten,  
 Wetterschenkel)  
**AV-02** Bodenprofil

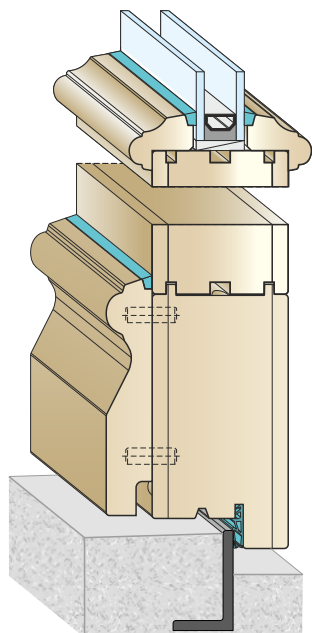

ALTERNATIVAUSFÜHRUNG  
**SOFT** (Glasleisten,  
 Wetterschenkel)  
**AV-07** Bodenprofil

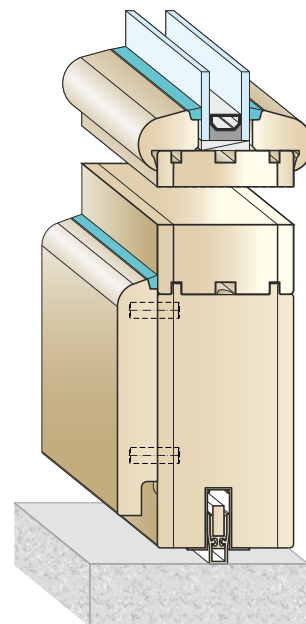



RC2 wir beraten Sie dazu gerne ausführlich.

Die Sicherheit einer Immobilie war und ist ein aktuelles Thema bei dem Kauf von Holz- und Holz/Alu-Haustüren. Ergänzend zu dem in diesem Sinne hohen Qualitätsstandard der Holz- und Holz/Alu-Haustüren als solches, sind diese mit **3-fach Verriegelung als Standardverriegelung ausgerüstet**. Des Weiteren erhalten Sie ISARHOLZ- Holz- und Holz/Alu-Haustüren in den **zertifizierten Sicherheitsstufen RC2**. Darüber hinaus stehen Ihnen weitere detailrelevante Verriegelungen zur Verfügung. Für einen hohen Bedienungs-komfort erhalten Sie individuelle Einrichtungen.

1 BANDSICHERUNG



2 SICHERHEITSGLAS P4A



3 SCHLIEßLEISTE EINTEILIG



4 SICHERHEITSPROFILZYLINDER MIT ANBOHRSCHUTZ

5 SICHERHEITSGARNITUR



3 TÜRBÄNDER



BAKA PROTECT 4010 3D FD  
- BAND HH 68  
Dreidimensional verstellbar



TETCUS TE 540 3D  
- VERDECKTLIEGENDES BAND HH 80  
Dreidimensional verstellbar

4 TÜRSCHWELLEN



BKV 80 TB  
HH 68



BKV 40 TB  
HH 80

# SICHERHEITSTÜRVERSCHLÜßE

**STV-1** (Standardausführung)  
**3-fach Verriegelung**  
**2 Kraftkeil**

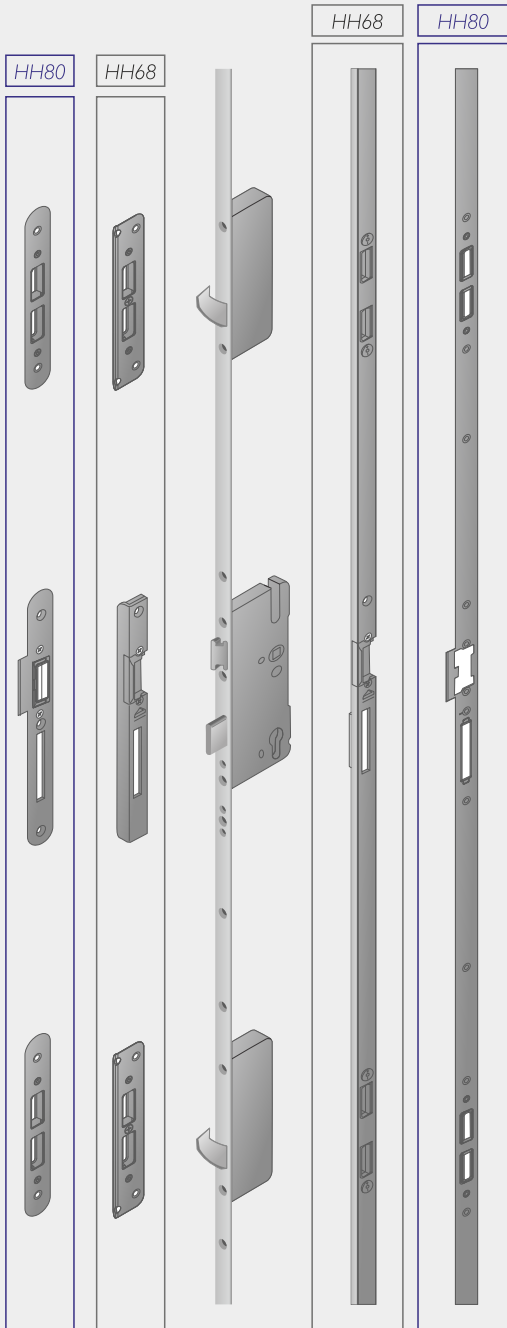

**STV-1K**  
**MECHANISCHER**  
**TÜRVERSCHLUß**  
**mit Komfortfunktion**  
**5-fach Verriegelung**

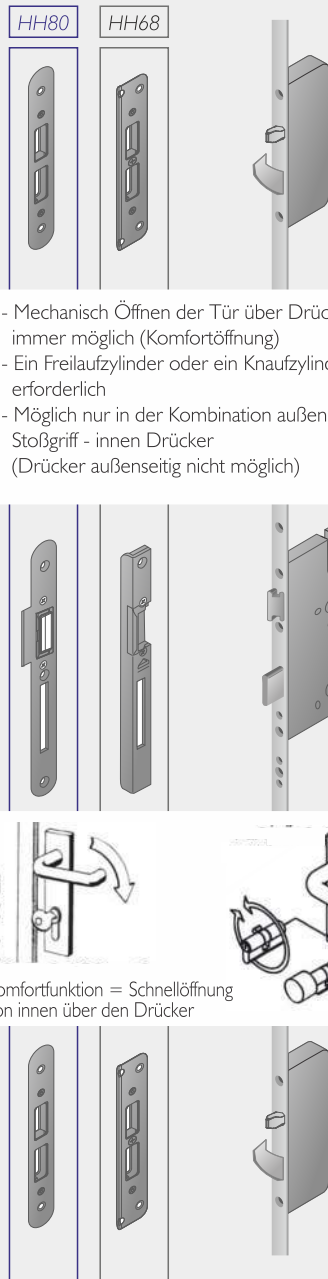

- Mechanisch Öffnen der Tür über Drücker immer möglich (Komfortöffnung)
- Ein Freilaufzylinder oder ein Knäufzylinder erforderlich
- Möglich nur in der Kombination außen Stoßgriff - innen Drücker (Drücker außenseitig nicht möglich)



Komfortfunktion = Schnellöffnung von innen über den Drücker

**STV-2**  
**5-fach Verriegelung**  
**4 Kraftkeil**

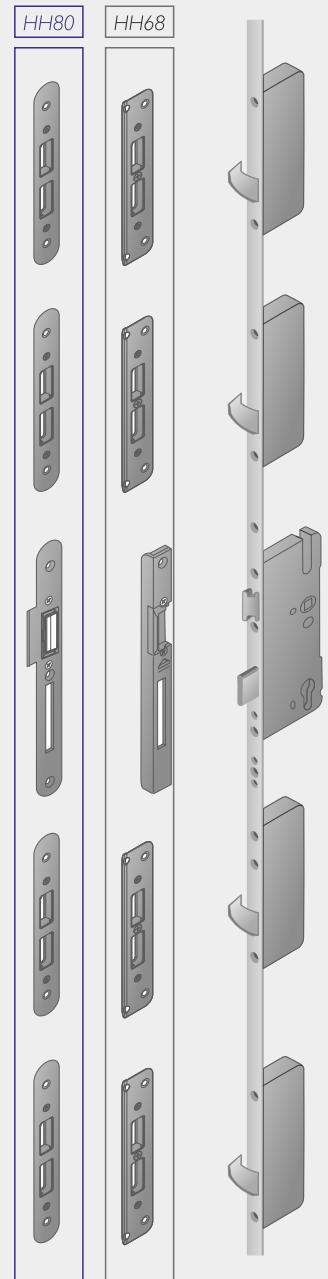

## PROFILZYLINDER

**KI STANDARD - PROFILZYLINDER N+G**  
 Profilzylinder mit Not- und Gefahrenfunktion mit 6 Schlüsseln verschiedenschließend



**KISK PROFILZYLINDER MIT KNOFF**  
 Profilzylinder mit Knopf und 6 Schlüsseln verschiedenschließend

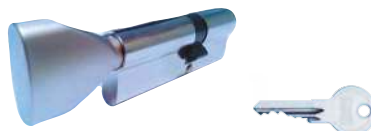

**K5 SICHERHEITS - PROFILZYLINDER N+G**  
 Profilzylinder mit Aufbohrschutz und 6 Schlüsseln verschiedenschließend





**STV-4**  
3-fach Verriegelung  
2 Automatikbolzen



**Tandeo**  
Tag/Nacht  
Umschalter

STV-4 ist mechanisch-automatische Mehrfachverriegelungssystem, bei dem die Verriegelungselemente automatisch ausfahren, sobald die Tür ins Schloss fällt. Bereits ohne Schlüsselbetätigung gilt das Schloss dank der VdS-zertifizierten Sicherheit versicherungstechnisch als verriegelt. Mit dem nachrüstbaren Tandeo Tag/Nacht Umschalter lässt sich die Schließautomatik bewusst ein- oder ausschalten.

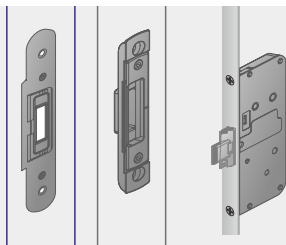

**STV-4-M**  
(E600-Eneo A)  
3-fach Verriegelung  
2 Automatikbolzen  
Mit motorischer Funktion  
inkl. Netzteil

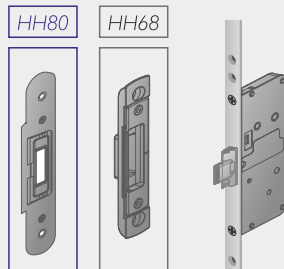

**E600-Eneo A** ist das elektromechanische Mehrfachverriegelungssystem bei dem die Vorteile der mechanisch-automatischen Verriegelung um den Komfort einer motorgetriebenen Entriegelung mittels Zutrittskontrollsysteme ergänzt sind. Optional lässt sich im Motor ein Funkempfänger integrieren. Durch den Einsatz eines E600 - Eneo A Schlosses wird die Tür mechanischautomatisch verriegelt, d.h. die Zusatzverriegelungen fahren automatisch aus, sobald die Tür ins Schloss fällt. Bereits ohne Schlüsselbetätigung gilt das Schloss dank der VdS-zertifizierten Sicherheit versicherungstechnisch als verriegelt.

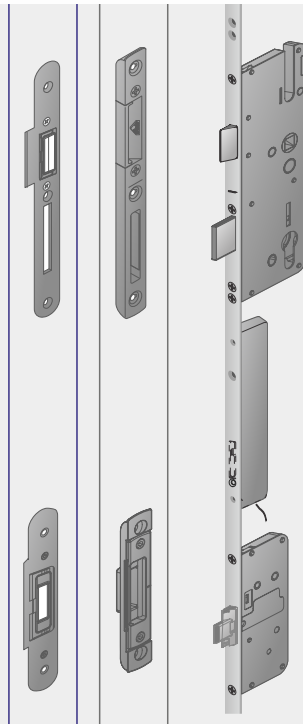

**E610-Eneo 2C**  
5-fach Verriegelung  
inkl. Netzteil

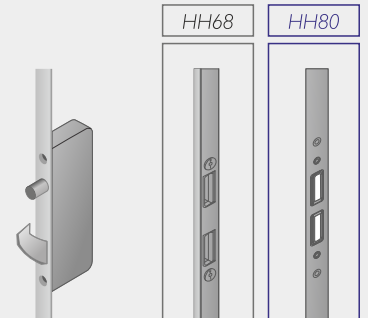

**E610-Eneo 2C** ist das elektromechanische Mehrfachverriegelungssystem bei dem Hauptschloss und Zusatzverriegelungen motorisch öffnen und verriegeln. Dank der Komfortöffnung lassen sich Haustüren im verriegelten Zustand immer von innen über den Türdrücker öffnen. So kann das Haus stets sicher verlassen werden, während die automatische Verriegelung Schutz vor Einbruch und Diebstahl bietet. In der Antriebseinheit ist serienmäßig ein Funkempfänger integriert. Mit dem nachrüstbaren Tag-Nacht-Schalter lässt sich die Schließautomatik bewusst ein- oder ausschalten.

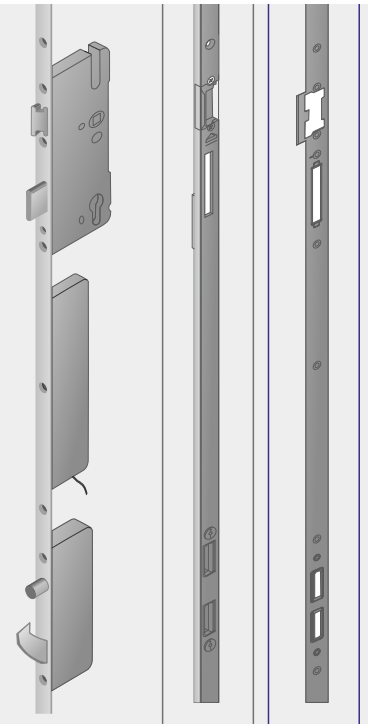

**Biometrisches System der Zugangskontrolle über Fingerabdruck**

Eine elegante Zutrittslösung, die direkt in das Türblatt, den Türrahmen, die Sprechanlage, den Briefkasten oder in die Wand integriert werden kann.

Funktionalität und edles Design wurden formvollendet verbunden. Ihr einzigartiger Fingerabdruck ist sicherer als jeder Schlüssel, der entwendet oder verloren werden kann.

Lediglich einzelne Merkmale werden erfasst und in einen binären Code umgewandelt.

Der Fingerabdruck wird nicht abgespeichert.



## Holz Haustür **aus**sen

Modell HT 862A, Serie TREND  
 Holz und Farbe: Flügel Lärche RL 200  
 Rahmen Ral 7037

HAUSNUMMER MOTIVGLAS



AUSSENROSETTE

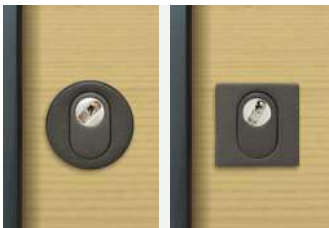

Schwarzstahl

Hausnummer Edelstahl



Edelstahl Applikation

BRIEFKASTEN-SYSTEME



WETTERSCHENKEL



WSE 03 als Edelstahl Applikation



WSE 01 aus Edelstahl



WSE 02 aus Edelstahl ohne Löcher

Holz Haustür innen

Modell HT 862A, Serie TREND  
 Holz und Farbe: Lärche RL 200

Türschließer TS 5000



INNENGRIFFE



TÜRBÄNDER, DRÜCKERGARNITUR





Türbänder, Halbgarnitur, Innengriffe und Rosetten farblich aufeinander abgestimmt

AUßENGRIFFE

<p>Edelstahl matt</p> <p>P 3202 L=350 mm    P 3214 L=1500 mm</p> <p>P 3204 L=550 mm    P 3216 L=1800 mm</p> <p>P 3206 L=750 mm    P 3218 L=2000 mm</p> <p>P 3208 L=950 mm    P 3217 L=X mm</p> <p>P 3210 L=1150 mm</p> <p>P 3212 L=1350 mm</p> <p>Schwarz</p> <p>P 3217 L = x</p>	<p>Edelstahl matt</p> <p>Mit schräger Befestigung</p> <p>316 865 L=400 mm</p> <p>316 866 L=600 mm</p> <p>316 867 L=800 mm</p> <p>316 868 L=1000 mm</p> <p>316 869 L=1200 mm</p> <p>Mit gerader Befestigung</p> <p>316 860 L=400 mm</p> <p>316 861 L=600 mm</p> <p>316 862 L=800 mm</p> <p>316 863 L=1000 mm</p> <p>316 864 L=1200 mm</p>	<p>Edelstahl matt</p> <p>314 585 L=400 mm</p> <p>314 586 L=800 mm</p> <p>314 597 L=1200 mm</p> <p>314 598 L=1600 mm</p> <p>316 847 L=1800 mm</p> <p>314 599 L=2000 mm</p> <p>Schwarzstahl - Optik</p> <p>316 870 L=1000 mm</p> <p>316 871 L=1200 mm</p> <p>316 872 L=1400 mm</p> <p>316 848 L=1600 mm</p> <p>316 849 L=1800 mm</p>	<p>Edelstahl matt / Holz</p> <p>SG-180 L=1200 mm</p>	<p>Edelstahl matt / Holz</p> <p>SG-124 L=1200 mm</p> <p>Mit integriertem Fingerprint</p> <p>SPSG-17 L=1200 mm</p> <p>Mit Mini-Kamera</p>
---	--	--	--	--

AUßENROSETTE

<p>Edelstahl</p>  <p>316 205    316 213    316 214</p>	<p>Schwarz</p>  <p>316 878    316 890    316 890</p>
---	---

SICHERHEITS ZYLINDERROSETTE









319 062 (68)    316 212    316 211  
316 207 (80)

KRATZERSCHUTZ



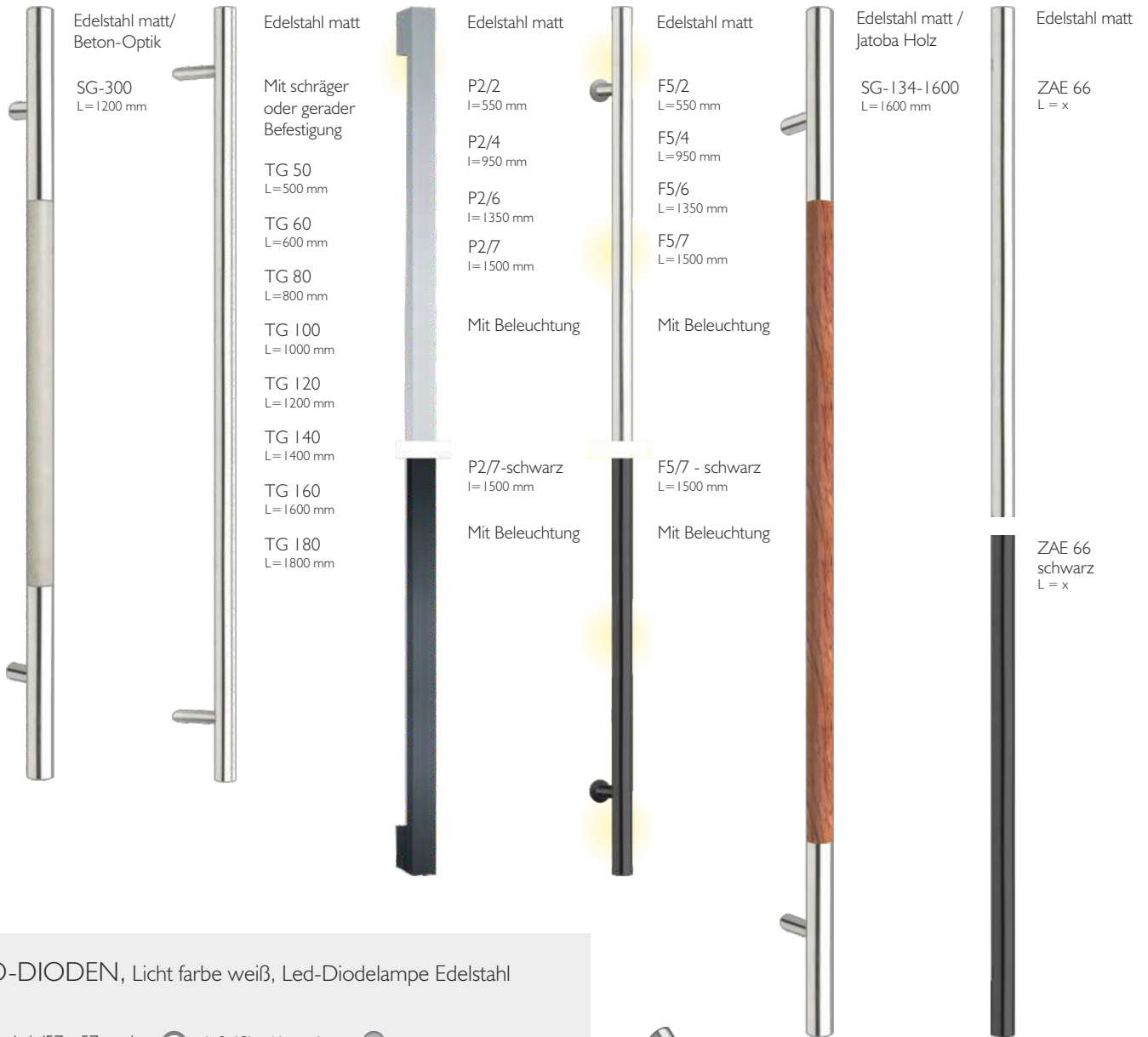

<p>Edelstahl</p>  <p>381 181 89 X 74 mm</p>	<p>Edelstahl</p>  <p>381 180 89 X 74 mm</p>
--	--

Mit integriertem Fingerprint

 <p>Edelstahl matt P 1182 L=550 mm</p>	 <p>Schwarz P 1182 L=550 mm</p>	 <p>Edelstahl matt P 1180 L=550 mm</p>	 <p>Schwarz P 1180 L=550 mm</p>	 <p>Edelstahl matt P 1179 L=550 mm</p>	 <p>Edelstahl E35303 L=330 mm E43303 L=400 mm E63303 L=600 mm</p>
---	--	---	--	--	--



LED-DIODEN, Licht farbe weiß, Led-Diodelampe Edelstahl

-  L 1 (57 x 57 mm)
-  L 2 (Ø=41 mm)
-  L 4 (Ø=35 mm)
-  L 3 (Ø=60 mm)
-  L 5 (Ø=30 mm)



STOßGRIFFE



SG-48



SG-79



SG-49



SG-83



SG-77

GRIFFSCHALEN



GS-11



GS-21



GS-20



GS-88



GS-74

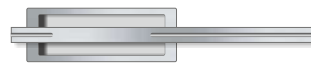

GS-113

V 107  
L=1400 mm



INTEGRIERTE GRIFFLEISTE



J 137 flächenbündig

integrierte Griffleiste - Ral farbe;  
sichtbarer Schliz = 45mm  
Länge in mm nach Wunsch

\* Nur für Holz-Alu Haustüren

TÜRKLOPFER



253 942

Messing- matt verchromt

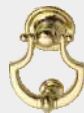

253 944

Messing- poliert schutzlackiert

NAMENSSCHILD



NSE I  
Edelstahl



255 506  
Messing poliert



255 510  
Messing poliert

SICHERHEITS-DRÜCKERGARNITUR



316 254 (L)  
316 255 (R)



319 567



314 866



316 839

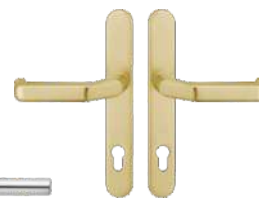

316 242



316 894 (L)  
316 895 (R)



316 722



ORNAMENTGLÄSER

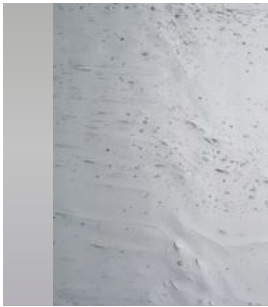

Altdeutsch weiss



Chinchilla weiss

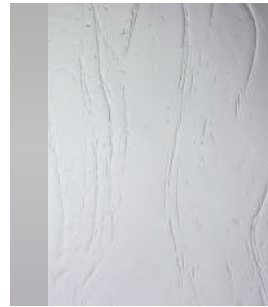

Gothic weiss

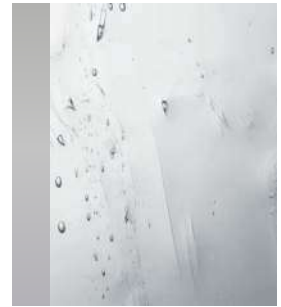

Altdeutsch K weiss

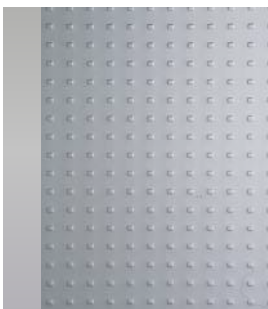

Mastercarre weiss



Masterligne weiss

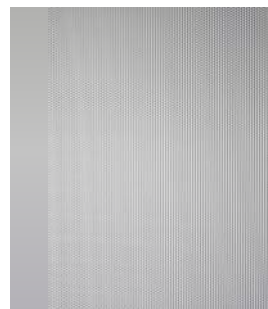

Masterpoint weiss



Satinato weiss

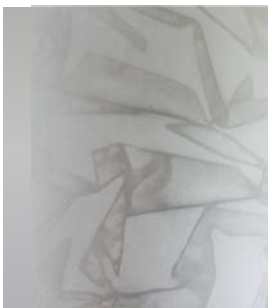

Silk weiss

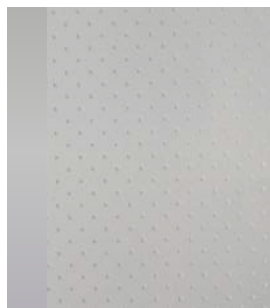

Pave weiss

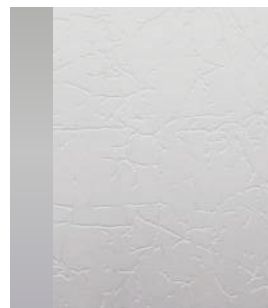

Uadi weiss

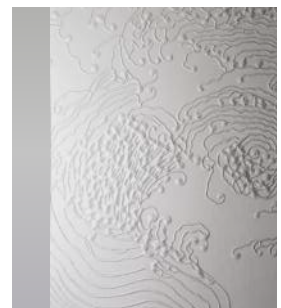

Nebulosa weiss

WÄRMESCHUTZGLAS

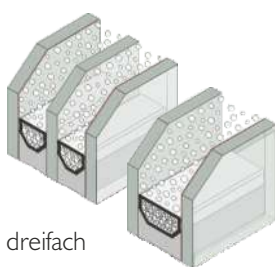

dreifach

zweifach

SANDGESTRAHLTE  
MOTIVE



GLAS MIT  
APPLIKATIONEN



BLEIVERGLASUNG  
MOTIVE



# FARBGESTALTUNGEN

Holzhaustüren; Holz/Alu-Haustüren innen

ZUR VERFÜGUNG STEHEN IHNEN FOLGENDE HOLZARTEN



Fichte



Kiefer



Lärche



Eiche



Meranti

LASURBESCHICHTUNG ( die Struktur des Holzes ist sichtbar )

## Fichte/Kiefer



RF 200



RFI ÖI



RFI NE

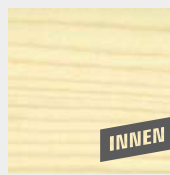

RFI I

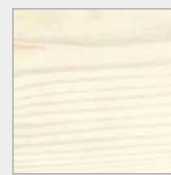

RF/K 10

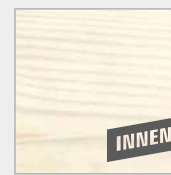

RFI 10



RF/K 11



RF/K 12

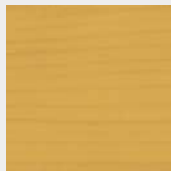

RF/K 19

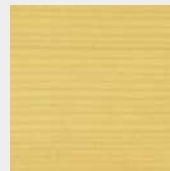

RF/K 21

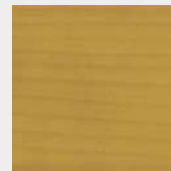

RF/K 22



RF/K 15



RF/K 16



RF/K 17

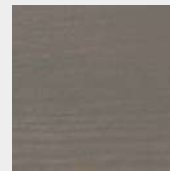

RF/K 26

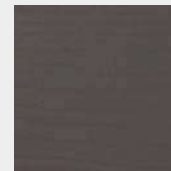

RF/K 27

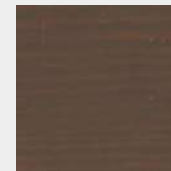

RF/K 25

## Kiefer



RK 1



RK 2



RK 4

## Grund



RG 1

## Lärche



RL 200



RL ÖI



RLI NE



RLI I



RL 21



RL 22



RL 23

## UMWELTFREUNDLICH

Für unser Dreischichtbeschichtungs-system verwenden wir umweltfreundliche Beschichtungen auf Wasserbasis.

Holzhaustüren; Holz/Alu-Haustüren innen

Eiche



ALTHOLZ

**NEU**

HOLZDEKOR ALTHOLZ

Lieferbar nur Modellen: HT 100, HTA 100

Oberfläche: roh, geölt oder grundiert



RE 200



RE Ö1



REI NE

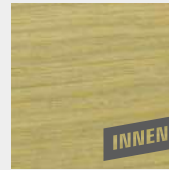

REI I



REI 10



RE 21

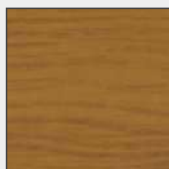

RE 22

Meranti



RM 21



RM 22



RM 23



RM 24



RM 25



RM 30



RM 31



RM 32

DECKENDBESCHICHTUNG (andere Deckende Farben nach RAL Farbkarte)

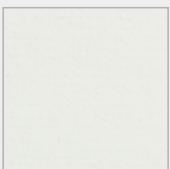

RD 21



RD 22



RD 25

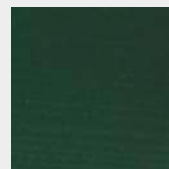

RD 44

Holz/Alu-Haustüren; Farben für die Alu-Schalen  
Auszug

## MASTER COLLECTION (feinstruktur, metallic)



Night Grey  
Feinstruktur Metallic



Cast Iron  
Feinstruktur Metallic



Russet Copper  
Feinstruktur Metallic



Brown  
Feinstruktur Metallic



Verdigris  
Feinstruktur Metallic



Granit Nature  
Feinstruktur Metallic



Volcanic Ash  
Feinstruktur Metallic



Elves Bench  
Feinstruktur Metallic

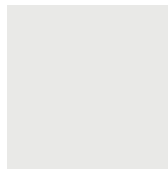

Artic Ice  
Feinstruktur Metallic



Precious Sand  
Feinstruktur Metallic



Iceberg Blue  
Feinstruktur Metallic



Rumbling Sky  
Feinstruktur Metallic

## ANODIZING COLLECTION (matt, metallic)

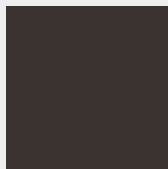

CARBON NIGHT  
Matt Metallic



DARK COPPER  
Matt Metallic



SIMPLY COPPER  
Matt Metallic



GREY BD  
Matt Metallic

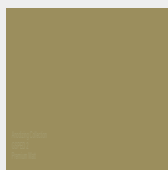

GSPED 2  
Matt



GSPED 3  
Matt



GSPED 4  
Matt



NOBLE BRONZE  
Matt Metallic

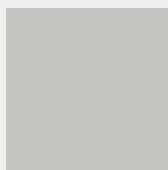

GSPED 0  
Matt



GSPED 1  
Matt



ORIGINAL PLATINIUM  
Matt Metallic

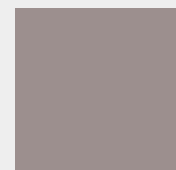

SILVER DREAM  
Matt Metallic

STEINDEKOR

NEU



Dekor Zement hell



Dekor Beton dunkel

HOLZDEKOR

NEU



Dekor Altholz



Dekor Stadelholz grau

RAL FARBEN

(matt, feinstruktur, metallic, glatt)

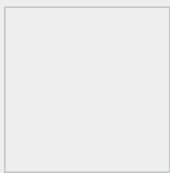

RAL 9016  
Matt/ Feinstruktur

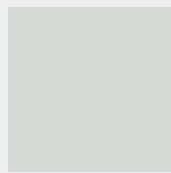

RAL 7035  
Matt/ Feinstruktur



RAL 7004  
Matt/ Feinstruktur

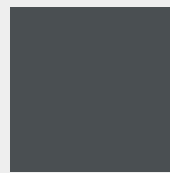

RAL 7016  
Matt/ Feinstruktur

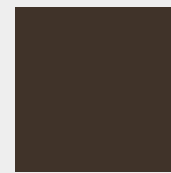

6768 BRAUN  
Feinstruktur

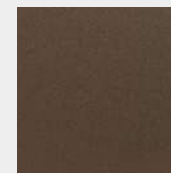

Rostiges eisen  
Feinstruktur

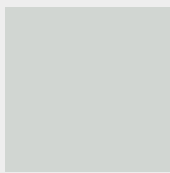

RAL 9006  
Metallic glatt



RAL 9007  
Metallic glatt



DB 703  
Metallic glatt



DB 703  
Metallic Feinstruktur



RAL 8017  
Matt/ Feinstruktur



RAL 5014  
Matt/ Feinstruktur



RAL 5014  
Matt/ Feinstruktur



RAL 5007  
Matt/ Feinstruktur



RAL 6005  
Matt/ Feinstruktur

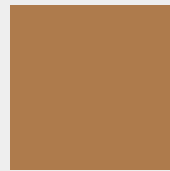

RAL 8001  
Matt/ Feinstruktur



RAL 8003  
Matt/ Feinstruktur

Holzdekor (struktur)



Douglas 2

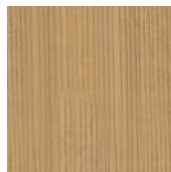

Douglas 6

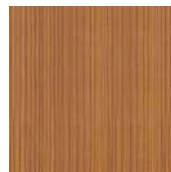

Douglas 7

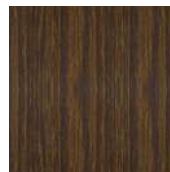

Eiche dunkel



Kirsch 2



Kirsch 3

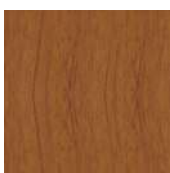

Eiche 4

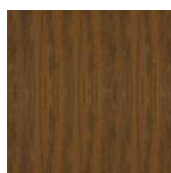

Eiche 2

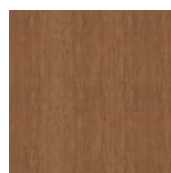

Golden Oak

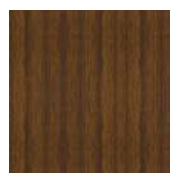

Nuss 1

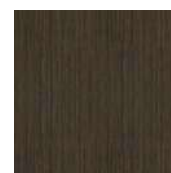

Wenge



Walnuss dunkel

**[www.isarholz.com](http://www.isarholz.com)**

Wir freuen uns, Sie persönlich zu beraten

